

6" - 8" - 10" 6-8-10LMG lines



CARATTERISTICHE COSTRUTTIVE / CONSTRUCTION FEATURES CARACTERÍSTICAS CONSTRUCTIVAS / CARACTÉRISTIQUES D'EXÉCUTION

Corpo d'Aspirazione e di Mandata Suction and delivery outlet	ghisa GG25 cast iron GG25
Caja de Aspiración y de Impulsión Cage d'aspiration et de refoulement	fundición GG25 fonte GG25
Valvola Valve Valvula Plat	AISI 304
Giranti e diffusori Impellers and diffusers Rodetes y difusores Turbines et diffuseurs	ghisa GG25; a richiesta giranti AISI 304 cast iron GG25; AISI 304 impeller on request fundición GG25; bajo pedido rodetes AISI 304 fonte GG25; sur demande turbines AISI 304
Bronzina superiore Upper bushings Cojinete superior Coussinet de bague supérieur	gomma NBR NBR rubber goma NBR caoutchouc NBR
Albero corpo pompa Shaft pump side Eje cuerpo bomba Arbre pompe	AISI 304
Quantità di sabbia nell'acqua Quantity of sand in the water Cantidad de arena en el agua Quantité de sable dans l'eau	max 50 gr/m³

MOTORE / MOTOR / MOTOR / MOTEUR

Asincrono 2 poli Asynchronous 2 pole Asíncrono 2 polos Asinchrone 2 pôles	riavvolgibile in bagno d'acqua rewindable water cooled bobinable en baño de agua enroulable en bain d'eau
Classe di isolamento Insulation class Clase de aislamiento Classe d'isolation	Y (max 30 °C) F (max 50 °C)
Grado di protezione Protection degree Grado de protección protection	IP68
Temperatura del liquido Liquid temperature Temperatura del líquido Température du liquide	max 30 °C (su richiesta max 50 °C) max 30 °C (max 50 °C on request) max 30 °C (bajo pedido max 50 °C) max 30 °C (sur demande max 50 °C)

Pompe sommerse centrifughe multistadio per pozzi da 6", 8", 10". Valvola di ritegno incorporata nella bocca di mandata. Flangia di accoppiamento al motore secondo la normativa NEMA. Applicazioni civili e agricole sono tra le più comuni.

Submersible multistage centrifugal pumps for 6", 8", 10" wells. Check valve built into the delivery outlet. Pump flange for coupling with motors are made according to NEMA standards. Most common applications are civil and agricultural.

Bombas sumergibles para pozos de 6", 8", 10". Válvula de retención incorporada en la boca de impulsión. Brida de conexión al motor según norma NEMA. Utilizadas en particular para aplicaciones civiles y agrícolas.

Pompes immergées centrifuges multietagées pour puits de 6", 8", 10". Clapet de retenue incorporé dans l'orifice de refoulement. Bride d'accouplement au moteur est exécutée selon normes NEMA. Les applications civiles et agricoles sont parmi les plus communes.

6" 6LMG 38

Motor 50 Hz - 2900 rpm				Q							
TYPE	Power		400 V	l/min l/sec	0	300	400	500	600	700	800
	(HP)	(kW)			0	5,00	6,67	8,33	10,00	11,67	13,33
	A	m ³ /h	0	18	24	30	36	42	48		
6LMG 38/03	5,5	4	7,5	H[m]	43	36	33	30	27	22	15
6LMG 38/04	7,5	5,5	12,5		57	48	44	40	37	30	20
6LMG 38/05	10	7,5	17,5		71	60	55	50	46	37	25
6LMG 38/06	10	7,5	17,5		86	72	66	60	55	45	30
6LMG 38/07	12,5	9,2	21		100	84	77	70	64	52	35
6LMG 38/08	15	11	24,5		114	96	88	80	73	59	40
6LMG 38/09	15	11	24,5		129	108	99	90	82	67	45
6LMG 38/10	17,5	13	28		143	120	110	100	91	74	50
6LMG 38/11	17,5	13	28		157	132	121	110	101	82	55
6LMG 38/12	20	15	32		171	144	132	120	110	89	60
6LMG 38/13	20	15	32		186	156	143	130	119	97	65
6LMG 38/14	25	18,5	40		200	168	154	140	128	104	70
6LMG 38/15	25	18,5	40		214	180	165	150	137	111	75

Motor 50 Hz 2900 rpm	Dimensions (mm)			Weight (kg)	
TYPE	A	B	C	M	P
6LMG 38/03	1242	596	646	40	19
6LMG 38/04	1368	697	671	45	23
6LMG 38/05	1499	798	701	55	28
6LMG 38/06	1600	899	701	55	32
6LMG 38/07	1751	1000	751	60	36
6LMG 38/08	1912	1101	811	65	40
6LMG 38/09	2013	1202	811	65	44
6LMG 38/10	2144	1303	841	70	48
6LMG 38/11	2245	1404	841	70	52
6LMG 38/12	2436	1505	931	75	56
6LMG 38/13	2537	1606	931	75	60
6LMG 38/14	2698	1707	991	83	64
6LMG 38/15	2799	1808	991	83	69

Max Eff. % =	74
Max kW / St. =	1,22

Q (flow)	25%	50%	75%	100%
NPSH (m)	3,4	3,4	3,8	8

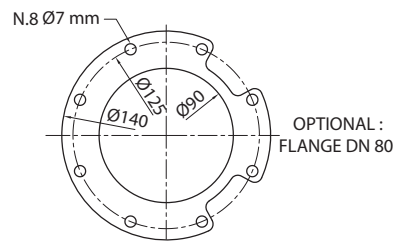
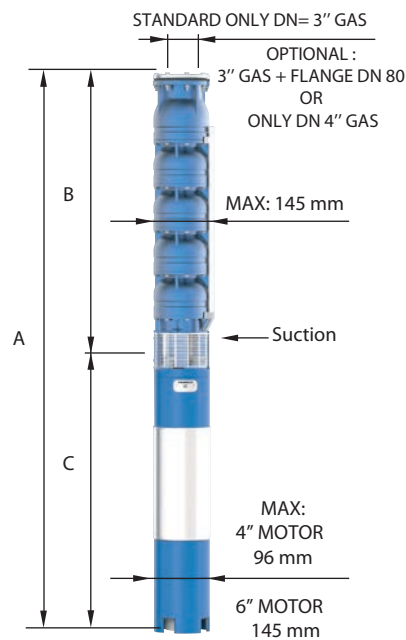

FOR COMMERCIAL TUBE
EXTERNAL DIAMETER: 88,9 mm

Tolleranza alla sabbia 50 g/m³ - sand tolerance 50 g/m³

MEI ≥ 0,4 (direttiva EU No. 547/2012 - regulation EU N. 547/2012)

Tolleranze secondo UNI ISO 9906 livello 3B - Tolerances according to UNI ISO 9906 grade 3B



6" 6LMG 38

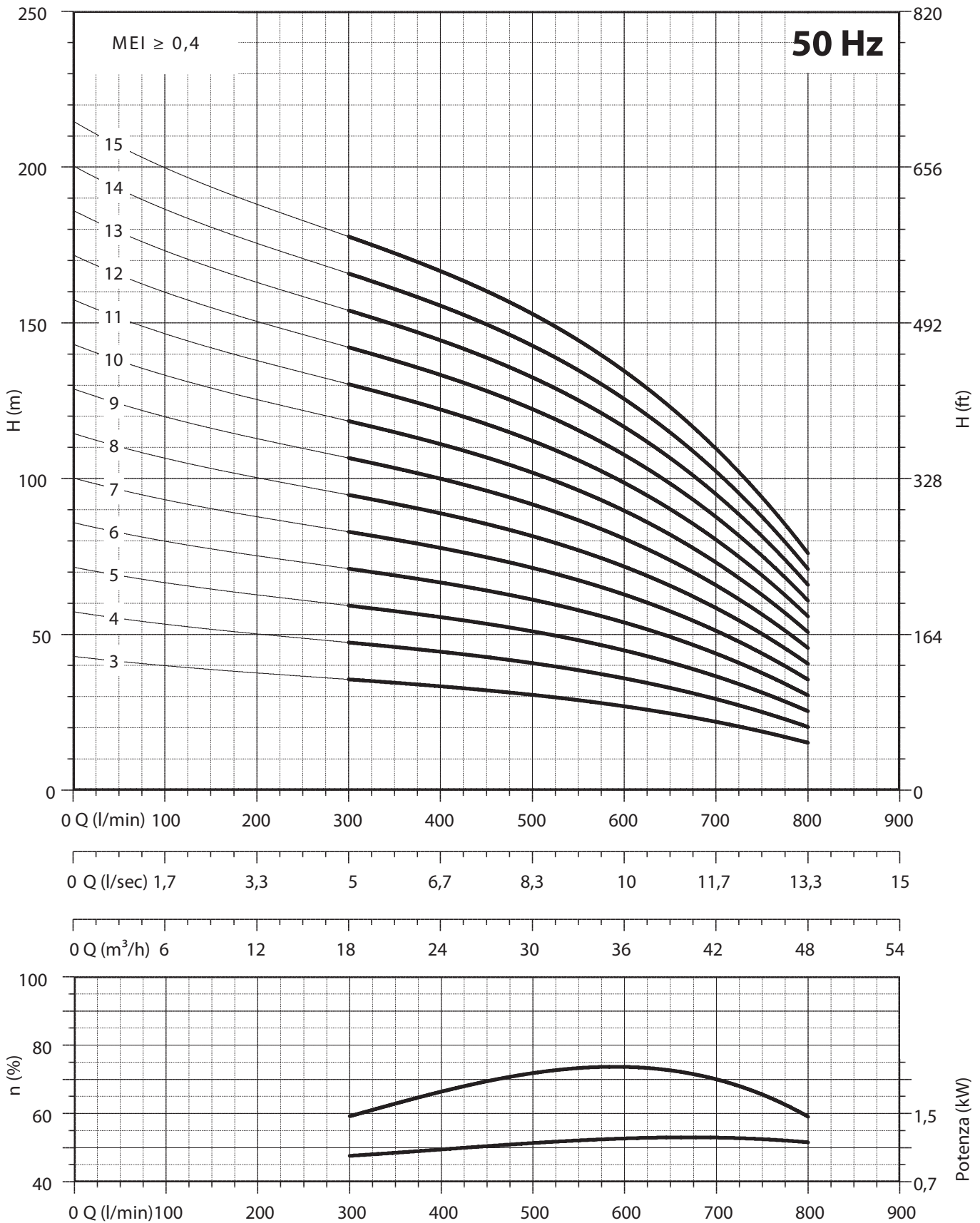

Tolleranza alla sabbia 50 g/m³ - sand tolerance 50 g/m³

MEI $\geq 0,4$ (direttiva EU No. 547/2012 - regulation EU N. 547/2012)

Tolleranze secondo UNI ISO 9906 livello 3B - Tolerances according to UNI ISO 9906 grade 3B



6" 6LMG 38

Motor 50 Hz - 2900 rpm				Q							
TYPE	Power		400 V	l/min	0	300	400	500	600	700	800
	(HP)	(kW)	A	l/sec	0	5,00	6,67	8,33	10,00	11,67	13,33
				m³/h	0	18	24	30	36	42	48
6LMG 38/16	30	22	47,5	H[m]	229	192	176	160	146	119	80
6LMG 38/17	30	22	47,5		243	204	187	170	155	126	85
6LMG 38/18	30	22	47,5		257	216	198	180	165	134	90
6LMG 38/19	35	26	55		271	228	209	190	174	141	95
6LMG 38/20	35	26	55		286	240	220	200	183	149	100
6LMG 38/21	35	26	55		300	252	231	210	192	156	105
6LMG 38/22	35	26	55		314	264	242	220	201	163	110
6LMG 38/23	40	30	62,5		329	276	253	230	210	171	115
6LMG 38/24	40	30	62,5		343	288	264	240	219	178	120
6LMG 38/25	40	30	62,5		357	300	275	250	229	186	125
6LMG 38/26	50	37	78		371	312	286	260	238	193	130
6LMG 38/27	50	37	78		386	324	297	270	247	201	135
6LMG 38/28	50	37	78		400	336	308	280	256	208	140
6LMG 38/29	50	37	78		414	348	319	290	265	215	145
6LMG 38/30	50	37	78		429	360	330	300	274	223	150

Motor 50 Hz 2900 rpm	Dimensions (mm)			Weight (kg)	
TYPE	A	B	C	M	P
6LMG 38/16	2980	1909	1071	92	73
6LMG 38/17	3081	2010	1071	92	77
6LMG 38/18	3182	2111	1071	92	81
6LMG 38/19	3393	2212	1181	100	85
6LMG 38/20	3494	2313	1181	100	89
6LMG 38/21	3595	2414	1181	100	93
6LMG 38/22	3696	2515	1181	100	97
6LMG 38/23	3867	2616	1251	108	101
6LMG 38/24	3968	2717	1251	108	105
6LMG 38/25	4069	2818	1251	108	110
6LMG 38/26	4260	2919	1341	118	114
6LMG 38/27	4361	3020	1341	118	118
6LMG 38/28	4462	3121	1341	118	122
6LMG 38/29	4563	3222	1341	118	126
6LMG 38/30	4664	3323	1341	118	130

Max Eff. % =	74
Max kW / St. =	1,22

Q (flow)	25%	50%	75%	100%
NPSH (m)	3,4	3,4	3,8	8

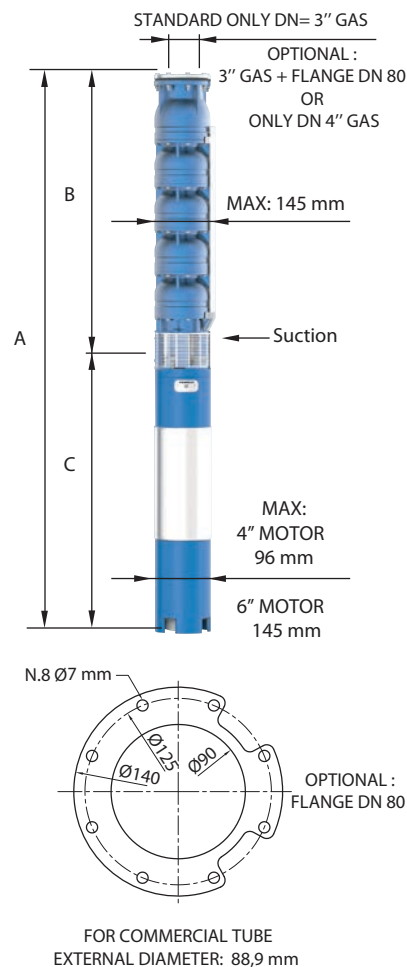

Tolleranza alla sabbia 50 g/m³ - sand tolerance 50 g/m³

MEI ≥ 0,4 (direttiva EU No. 547/2012 - regulation EU N. 547/2012)

Tolleranze secondo UNI ISO 9906 livello 3B - Tolerances according to UNI ISO 9906 grade 3B



6" 6LMG 38

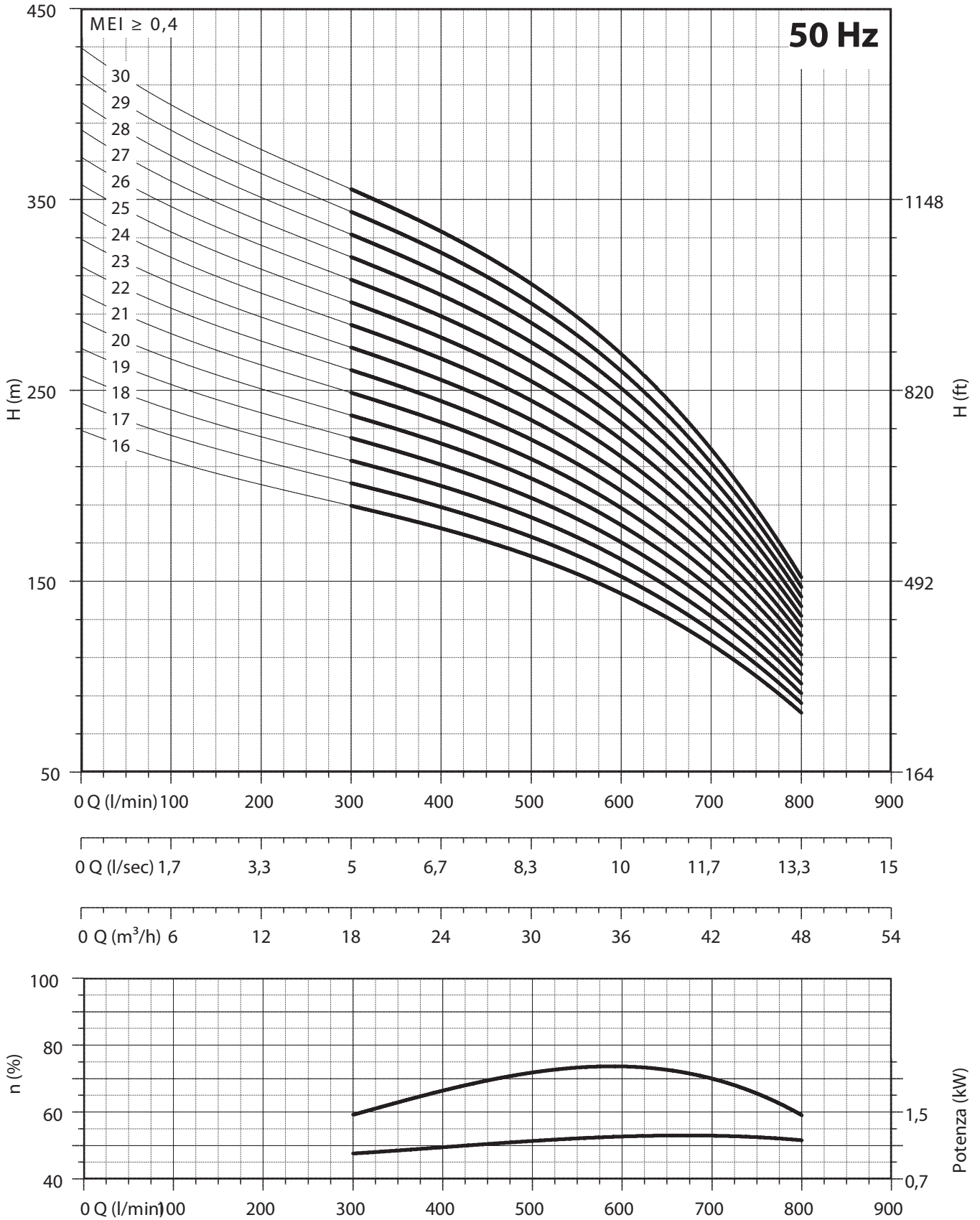

Tolleranza alla sabbia 50 g/m³ - sand tolerance 50 g/m³

MEI $\geq 0,4$ (direttiva EU No. 547/2012 - regulation EU N. 547/2012)

Tolleranze secondo UNI ISO 9906 livello 3B - Tolerances according to UNI ISO 9906 grade 3B



6" 6LMG 48

Motor 50 Hz - 2900 rpm				Q								
TYPE	Power		400 V	l/min l/sec	0	400	500	600	700	800	900	1000
	(HP)	(kW)			0	6,67	8,33	10,00	11,67	13,33	15,00	16,67
	A	m ³ /h	0	24	30	36	42	48	54	60		
6LMG 48/03	5,5	4	7,5	H[m]	40	32	31	29	26	22	17	10
6LMG 48/04	7,5	5,5	12,5		53	43	41	38	34	29	22	13
6LMG 48/05	10	7,5	17,5		67	53	51	48	43	36	28	17
6LMG 48/06	12,5	9,2	21		80	64	61	57	51	43	33	20
6LMG 48/07	12,5	9,2	21		93	75	71	67	60	50	39	23
6LMG 48/08	15	11	24,5		107	85	81	76	68	57	44	27
6LMG 48/09	17,5	13	28		120	96	92	86	77	65	50	30
6LMG 48/10	17,5	13	28		133	107	102	95	85	72	55	33
6LMG 48/11	20	15	32		147	117	112	105	94	79	61	37
6LMG 48/12	20	15	32		160	128	122	114	102	86	66	40
6LMG 48/13	25	18,5	40		173	139	132	124	111	93	72	43
6LMG 48/14	25	18,5	40		187	149	142	133	119	100	77	47
6LMG 48/15	30	22	47,5		200	160	153	143	128	108	83	50

Motor 50 Hz 2900 rpm	Dimensions (mm)			Weight (kg)	
TYPE	A	B	C	M	P
6LMG 48/03	1242	596	646	40	19
6LMG 48/04	1368	697	671	45	23
6LMG 48/05	1499	798	701	55	28
6LMG 48/06	1650	899	751	60	32
6LMG 48/07	1751	1000	751	60	36
6LMG 48/08	1912	1101	811	65	40
6LMG 48/09	2043	1202	841	70	44
6LMG 48/10	2144	1303	841	70	48
6LMG 48/11	2335	1404	931	75	52
6LMG 48/12	2436	1505	931	75	56
6LMG 48/13	2597	1606	991	83	60
6LMG 48/14	2698	1707	991	83	64
6LMG 48/15	2879	1808	1071	92	69

Max Eff. % =	74
Max kW / St. =	1,32

Q (flow)	25%	50%	75%	100%
NPSH (m)	3,45	3,5	3,8	5

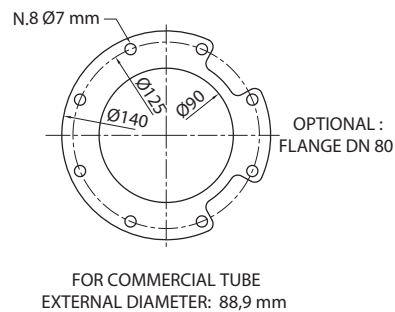
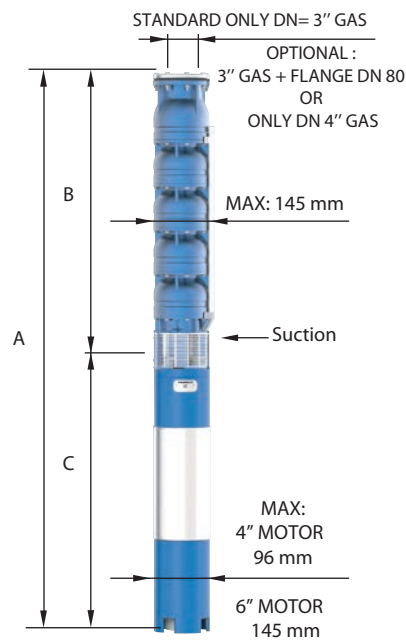

Tolleranza alla sabbia 50 g/m³ - sand tolerance 50 g/m³

MEI ≥ 0,4 (direttiva EU No. 547/2012 - regulation EU N. 547/2012)

Tolleranze secondo UNI ISO 9906 livello 3B - Tolerances according to UNI ISO 9906 grade 3B



6" 6LMG 48

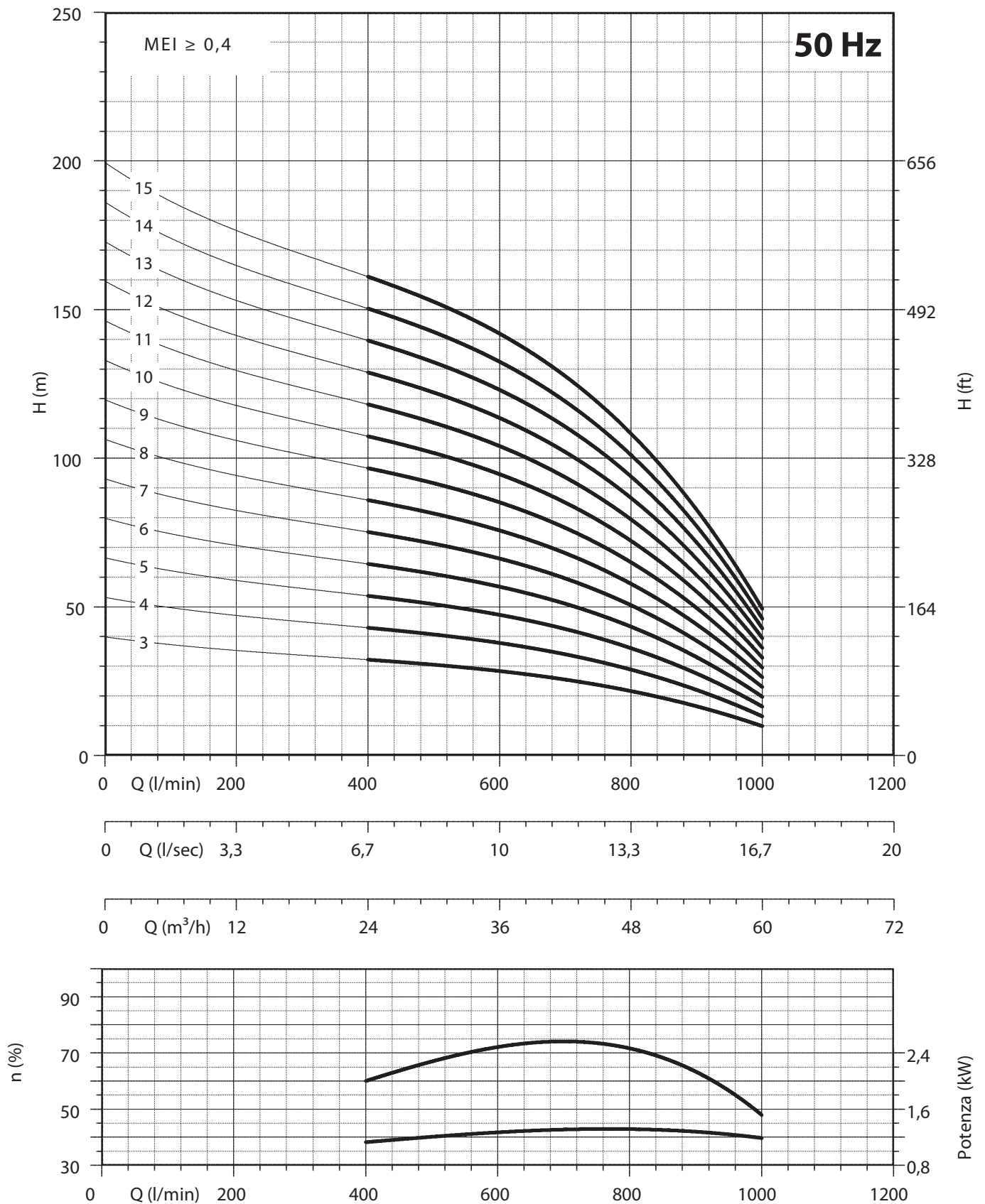

Tolleranza alla sabbia 50 g/m³ - sand tolerance 50 g/m³

MEI $\geq 0,4$ (direttiva EU No. 547/2012 - regulation EU N. 547/2012)

Tolleranze secondo UNI ISO 9906 livello 3B - Tolerances according to UNI ISO 9906 grade 3B



6" 6LMG 48

Motor 50 Hz - 2900 rpm				Q								
TYPE	Power		400 V	l/min l/sec	0	400	500	600	700	800	900	1000
	(HP)	(kW)			0	6,67	8,33	10,00	11,67	13,33	15,00	16,67
	A	m ³ /h	0	24	30	36	42	48	54	60		
6LMG 48/16	30	22	47,5	H[m]	213	171	163	152	136	115	88	53
6LMG 48/17	30	22	47,5		227	181	173	162	145	122	94	57
6LMG 48/18	35	26	55		240	192	183	171	153	129	99	60
6LMG 48/19	35	26	55		253	203	193	181	162	136	105	63
6LMG 48/20	35	26	55		267	213	203	190	170	143	110	67
6LMG 48/21	40	30	62,5		280	224	214	200	179	151	116	70
6LMG 48/22	40	30	62,5		293	235	224	209	187	158	121	73
6LMG 48/23	40	30	62,5		307	245	234	219	196	165	127	77
6LMG 48/24	50	37	78		320	256	244	228	204	172	132	80
6LMG 48/25	50	37	78		333	267	254	238	213	179	138	83
6LMG 48/26	50	37	78		347	277	264	247	221	186	143	87
6LMG 48/27	50	37	78		360	288	275	257	230	194	149	90
6LMG 48/28	50	37	78		373	299	285	266	238	201	154	93

Motor 50 Hz 2900 rpm	Dimensions (mm)			Weight (kg)	
TYPE	A	B	C	M	P
6LMG 48/16	2980	1909	1071	92	73
6LMG 48/17	3081	2010	1071	92	77
6LMG 48/18	3292	2111	1181	100	81
6LMG 48/19	3393	2212	1181	100	85
6LMG 48/20	3494	2313	1181	100	89
6LMG 48/21	3665	2414	1251	108	93
6LMG 48/22	3766	2515	1251	108	97
6LMG 48/23	3867	2616	1251	108	101
6LMG 48/24	4058	2717	1341	118	105
6LMG 48/25	4159	2818	1341	118	110
6LMG 48/26	4260	2919	1341	118	114
6LMG 48/27	4361	3020	1341	118	118
6LMG 48/28	4462	3121	1341	118	122

Max Eff. % =	74
Max kW / St. =	1,32

Q (flow)	25%	50%	75%	100%
NPSH (m)	3,45	3,5	3,8	5

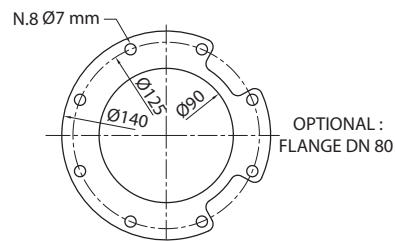
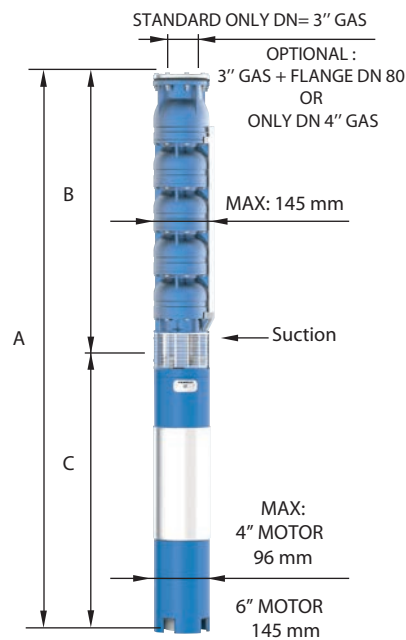

FOR COMMERCIAL TUBE
EXTERNAL DIAMETER: 88,9 mm

Tolleranza alla sabbia 50 g/m³ - sand tolerance 50 g/m³

MEI ≥ 0,4 (direttiva EU No. 547/2012 - regulation EU N. 547/2012)

Tolleranze secondo UNI ISO 9906 livello 3B - Tolerances according to UNI ISO 9906 grade 3B



6" 6LMG 48

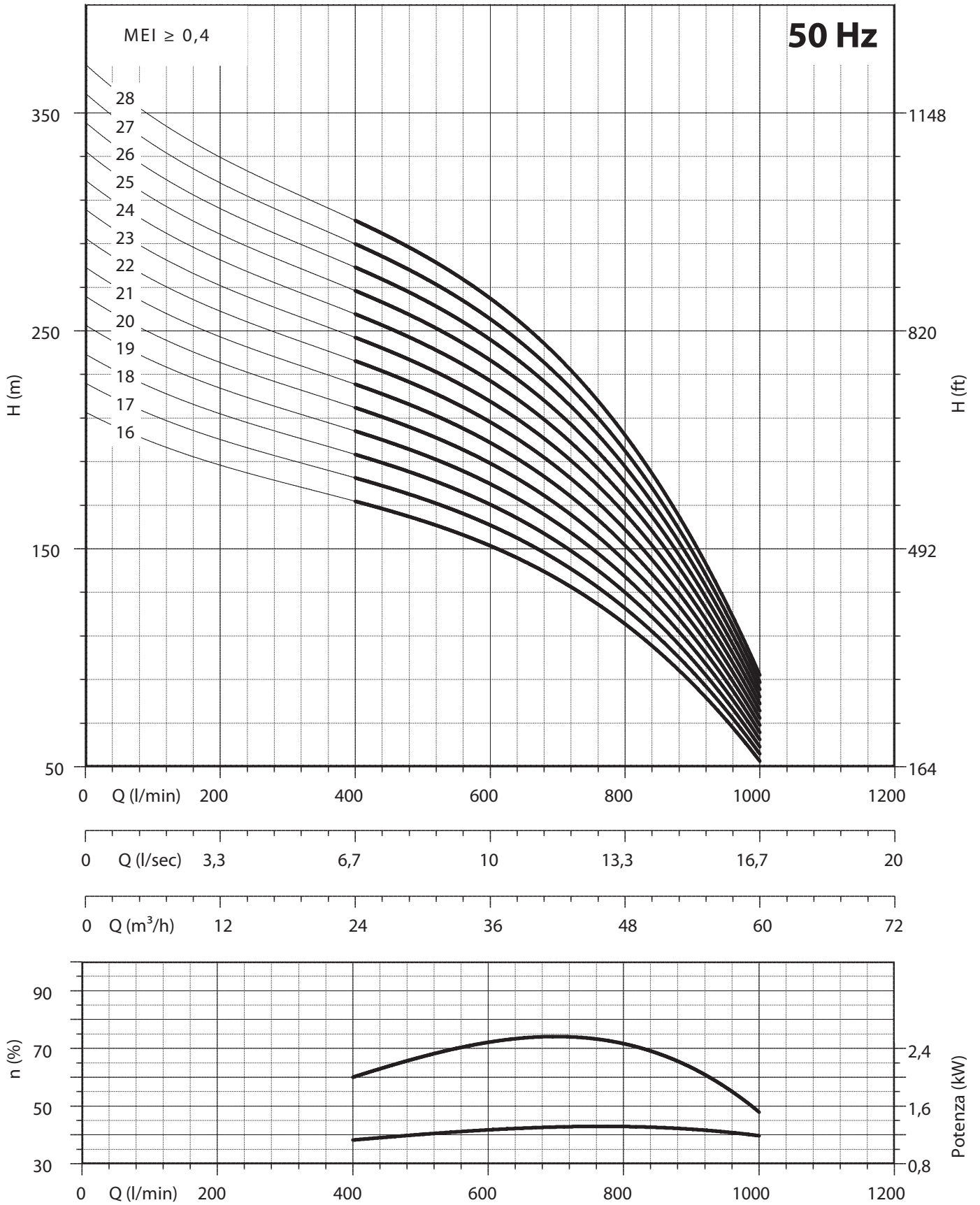

Tolleranza alla sabbia 50 g/m³ - sand tolerance 50 g/m³

MEI $\geq 0,4$ (direttiva EU No. 547/2012 - regulation EU N. 547/2012)

Tolleranze secondo UNI ISO 9906 livello 3B - Tolerances according to UNI ISO 9906 grade 3B



6" 6LMG 60

Motor 50 Hz - 2900 rpm				Q						
TYPE	Power		400 V	I/min	0	500	600	800	1000	1200
	(HP)	(kW)		I/sec	0	8,33	10,00	13,33	16,67	20,00
			A	m³/h	0	30	36	48	60	72
6LMG 60/03	7,5	5,5	12,5	H[m]	39	30	28	24	18	8
6LMG 60/04	10	7,5	17,5		52	40	38	32	24	10
6LMG 60/05	10	7,5	17,5		65	50	47	40	30	13
6LMG 60/06	12,5	9,2	21		78	60	56	48	35	16
6LMG 60/07	15	11	24,5		91	70	66	56	41	18
6LMG 60/08	17,5	13	28		104	80	75	64	47	21
6LMG 60/09	17,5	13	28		117	90	85	72	53	23
6LMG 60/10	20	15	32		130	100	94	80	59	26
6LMG 60/11	25	18,5	40		143	110	103	87	65	29
6LMG 60/12	25	18,5	40		156	120	113	95	71	31
6LMG 60/13	25	18,5	40		169	130	122	103	77	34
6LMG 60/14	30	22	47,5		182	140	132	111	83	36
6LMG 60/15	30	22	47,5		195	150	141	119	89	39
6LMG 60/16	35	26	55		208	160	150	127	94	42
6LMG 60/17	35	26	55		221	170	160	135	100	44
6LMG 60/18	35	26	55		234	180	169	143	106	47
6LMG 60/19	40	30	62,5		247	190	179	151	112	49
6LMG 60/20	40	30	62,5		260	200	188	159	118	52
6LMG 60/21	40	30	62,5		273	210	197	167	124	55
6LMG 60/22	50	37	78		286	220	207	175	130	57
6LMG 60/23	50	37	78		299	230	216	183	136	60
6LMG 60/24	50	37	78		312	240	226	191	142	62
6LMG 60/25	50	37	78		325	250	235	199	148	65

Motor 50 Hz 2900 rpm	Dimensions (mm)			Weight (kg)	
TYPE	A	B	C	M	P
6LMG 60/03	1285	614	671	45	21
6LMG 60/04	1422	721	701	55	25
6LMG 60/05	1529	828	701	55	30
6LMG 60/06	1686	935	751	60	34
6LMG 60/07	1853	1042	811	65	39
6LMG 60/08	1990	1149	841	70	43
6LMG 60/09	2097	1256	841	70	48
6LMG 60/10	2294	1363	931	75	52
6LMG 60/11	2461	1470	991	83	57
6LMG 60/12	2568	1577	991	83	61
6LMG 60/13	2675	1684	991	83	66
6LMG 60/14	2862	1791	1071	92	70
6LMG 60/15	2969	1898	1071	92	75
6LMG 60/16	3186	2005	1181	100	79
6LMG 60/17	3293	2112	1181	100	84
6LMG 60/18	3400	2219	1181	100	88
6LMG 60/19	3577	2326	1251	108	93
6LMG 60/20	3684	2433	1251	108	97
6LMG 60/21	3791	2540	1251	108	102
6LMG 60/22	3988	2647	1341	118	106
6LMG 60/23	4095	2754	1341	118	111
6LMG 60/24	4202	2861	1341	118	115
6LMG 60/25	4309	2968	1341	118	120

Max Eff. % =	73,6
Max kW / St. =	1,44

Q (flow)	25%	50%	75%	100%
NPSH (m)	3,8	3,8	5,1	7,1

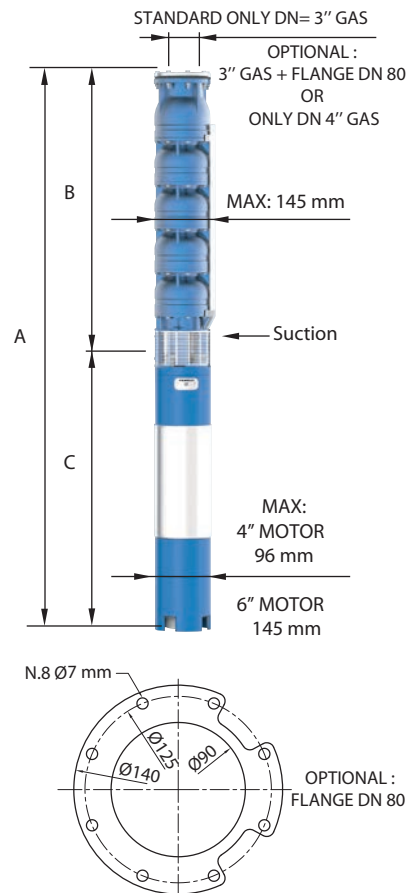

FOR COMMERCIAL TUBE
EXTERNAL DIAMETER: 88,9 mm

Tolleranza alla sabbia 50 g/m³ - sand tolerance 50 g/m³

MEI ≥ 0,4 (direttiva EU No. 547/2012 - regulation EU N. 547/2012)

Tolleranze secondo UNI ISO 9906 livello 3B - Tolerances according to UNI ISO 9906 grade 3B



6" 6LMG 60

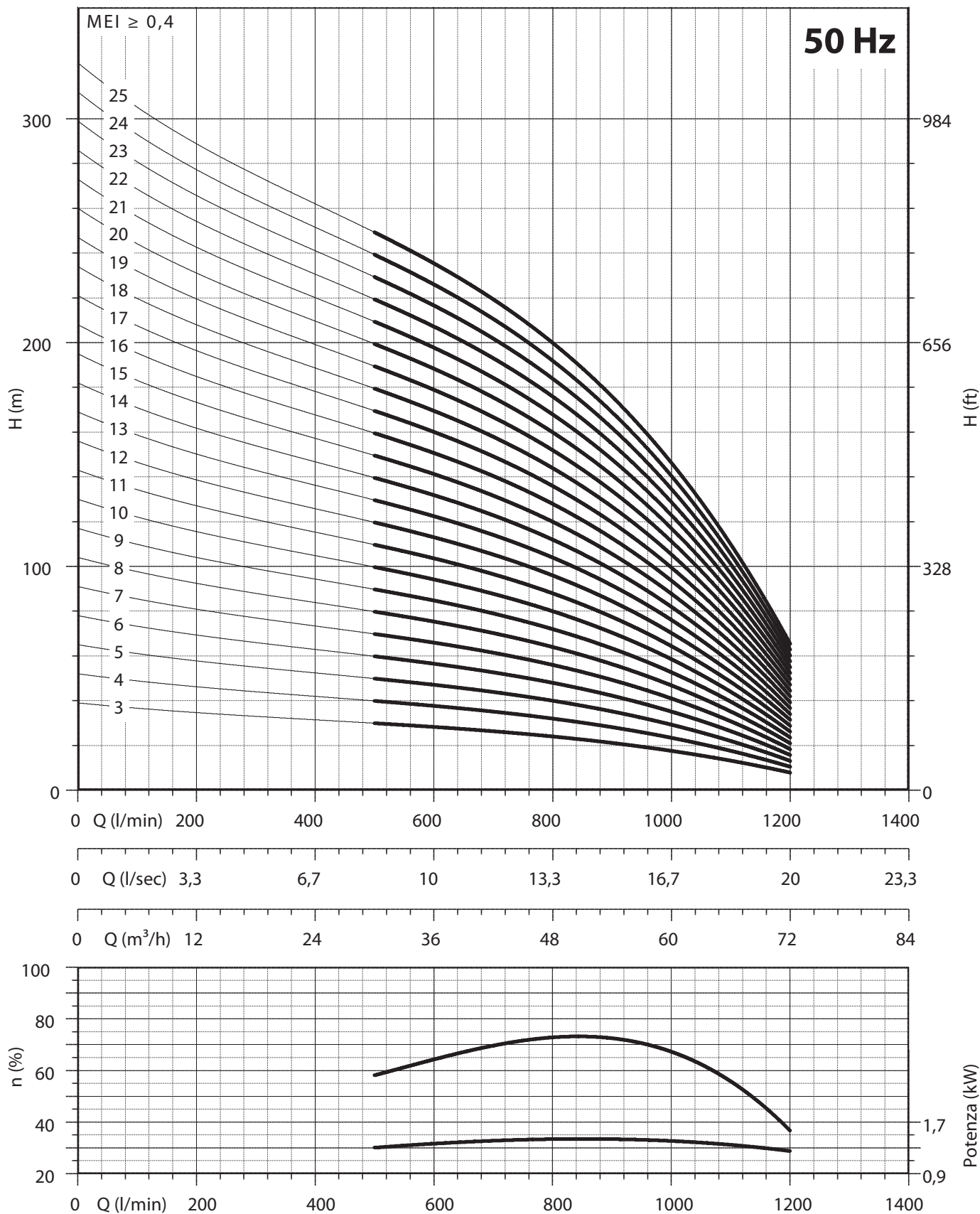

Tolleranza alla sabbia 50 g/m³ - sand tolerance 50 g/m³

MEI ≥ 0,4 (direttiva EU No. 547/2012 - regulation EU N. 547/2012)

Tolleranze secondo UNI ISO 9906 livello 3B - Tolerances according to UNI ISO 9906 grade 3B



6" 6LMG 70

Motor 50 Hz - 2900 rpm				Q						
TYPE	Power		400 V	l/min l/sec	0	600	800	1000	1200	1400
	(HP)	(kW)			0	10,00	13,33	16,67	20,00	23,33
	A	m ³ /h	0	36	48	60	72	84		
6LMG 70/03	7,5	5,5	12,5	H[m]	39	29	26	23	17	6
6LMG 70/04	10	7,5	17,5		52	39	35	31	23	8
6LMG 70/05	12,5	9,2	21		65	49	44	39	29	10
6LMG 70/06	15	11	24,5		78	59	53	47	34	12
6LMG 70/07	17,5	13	28		91	69	62	55	40	14
6LMG 70/08	20	15	32		104	78	70	62	46	16
6LMG 70/09	20	15	32		117	88	79	70	51	18
6LMG 70/10	25	18,5	40		130	98	88	78	57	20
6LMG 70/11	30	22	47,5		143	108	97	86	63	22
6LMG 70/12	30	22	47,5		156	118	106	94	68	24
6LMG 70/13	30	22	47,5		169	127	114	101	74	26
6LMG 70/14	35	26	55		182	137	123	109	80	28
6LMG 70/15	35	26	55		195	147	132	117	86	30
6LMG 70/16	40	30	62,5		208	157	141	125	91	32
6LMG 70/17	40	30	62,5		221	167	150	133	97	34
6LMG 70/18	50	37	78		234	176	158	140	103	36
6LMG 70/19	50	37	78		247	186	167	148	108	38
6LMG 70/20	50	37	78		260	196	176	156	114	40
6LMG 70/21	50	37	78		273	206	185	164	120	42

Motor 50 Hz 2900 rpm	Dimensions (mm)			Weight (kg)	
TYPE	A	B	C	M	P
6LMG 70/03	1285	614	671	45	21
6LMG 70/04	1422	721	701	55	25
6LMG 70/05	1579	828	751	60	30
6LMG 70/06	1746	935	811	65	34
6LMG 70/07	1883	1042	841	70	39
6LMG 70/08	2080	1149	931	75	43
6LMG 70/09	2187	1256	931	75	48
6LMG 70/10	2354	1363	991	83	52
6LMG 70/11	2541	1470	1071	92	57
6LMG 70/12	2648	1577	1071	92	61
6LMG 70/13	2755	1684	1071	92	66
6LMG 70/14	2972	1791	1181	100	70
6LMG 70/15	3079	1898	1181	100	75
6LMG 70/16	3256	2005	1251	108	79
6LMG 70/17	3363	2112	1251	108	84
6LMG 70/18	3560	2219	1341	118	88
6LMG 70/19	3667	2326	1341	118	93
6LMG 70/20	3774	2433	1341	118	97
6LMG 70/21	3881	2540	1341	118	102

Max Eff. % =	74
Max kW / St. =	1,74

Q (flow)	25%	50%	75%	100%
NPSH (m)	3,8	3,8	5,1	7,1

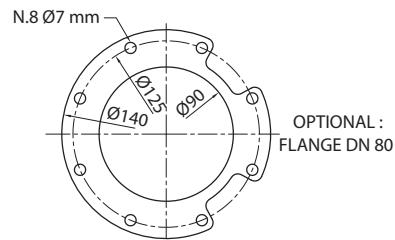
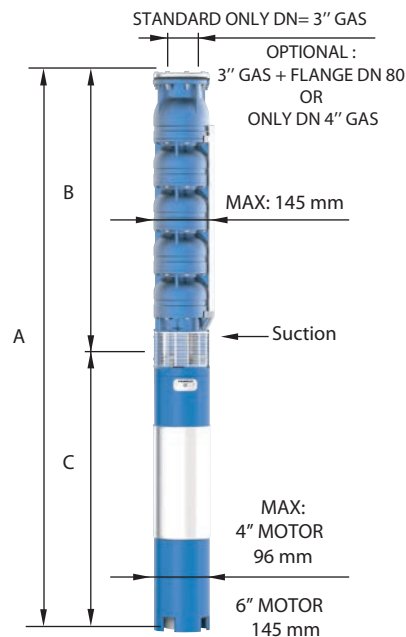

FOR COMMERCIAL TUBE
 EXTERNAL DIAMETER: 88,9 mm

Tolleranza alla sabbia 50 g/m³ - sand tolerance 50 g/m³

MEI ≥ 0,4 (direttiva EU No. 547/2012 - regulation EU N. 547/2012)

Tolleranze secondo UNI ISO 9906 livello 3B - Tolerances according to UNI ISO 9906 grade 3B



6" 6LMG 70

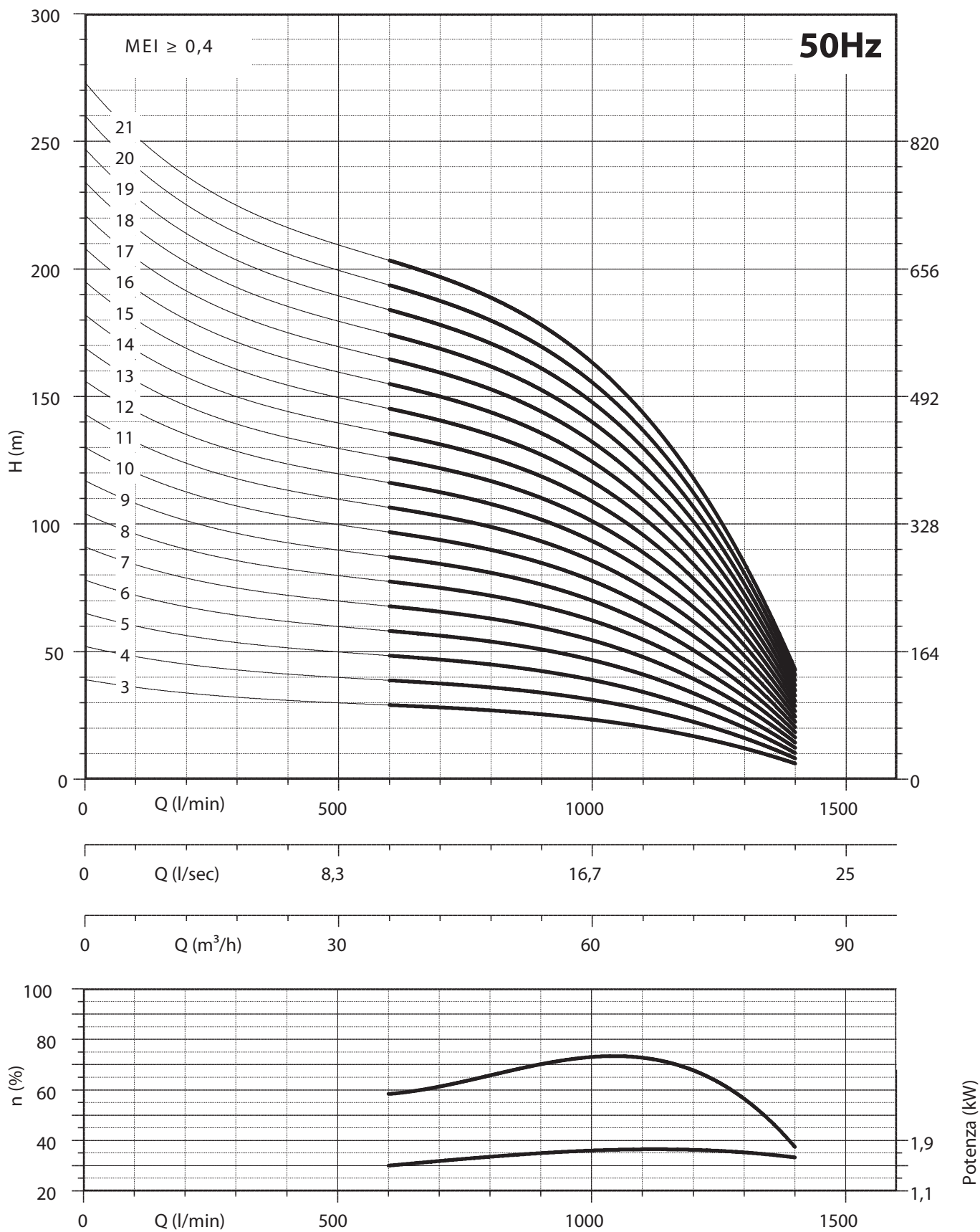

Tolleranza alla sabbia 50 g/m³ - sand tolerance 50 g/m³

MEI $\geq 0,4$ (direttiva EU No. 547/2012 - regulation EU N. 547/2012)

Tolleranze secondo UNI ISO 9906 livello 3B - Tolerances according to UNI ISO 9906 grade 3B



8" 8LMG 80

Motor 50 Hz - 2900 rpm				Q							
TYPE	Power		400 V	l/min	0	600	800	1000	1200	1400	1600
	(HP)	(kW)	A	l/sec	0	10,00	13,33	16,67	20,00	23,33	26,67
				m³/h	0	36	48	60	72	84	96
8LMG 80/01	7,5	5,5	12,5	H[m]	26	22	21	19	18	15	11
8LMG 80/02	15	11	24,5		53	45	42	39	35	30	23
8LMG 80/03	20	15	32		79	67	63	58	53	44	34
8LMG 80/04	30	22	47,5		105	89	84	78	70	59	45
8LMG 80/05	35	26	55		131	111	105	97	88	74	56
8LMG 80/06	40	30	62,5		158	134	126	116	105	89	68
8LMG 80/07	50	37	78		184	156	147	136	123	103	79
8LMG 80/08	60	45	92		210	178	168	155	140	118	90
8LMG 80/09	60	45	92		236	200	189	174	158	133	101
8LMG 80/10	75	55	113,5		263	223	210	194	175	148	113
8LMG 80/11	75	55	113,5		289	245	231	213	193	162	124
8LMG 80/12	90	66	134,5		315	267	252	233	210	177	135
8LMG 80/13	90	66	134,5		341	289	273	252	228	192	146
8LMG 80/14	100	75	149,5		368	312	294	271	245	207	158
8LMG 80/15	100	75	149,5		394	334	315	291	263	221	169

Motor 50 Hz 2900 rpm	Dimensions (mm)			Weight (kg)	
TYPE	A	B	C	M	P
8LMG 80/01	1198	527	671	45	23
8LMG 80/02	1463	652	811	65	31
8LMG 80/03	1708	777	931	75	39
8LMG 80/04	1973	902	1071	92	48
8LMG 80/05	2208	1027	1181	100	56
8LMG 80/06	2403	1152	1251	108	64
8LMG 80/07	2618	1277	1341	118	73
8LMG 80/08	2525	1402	1123	178	81
8LMG 80/09	2650	1527	1123	178	89
8LMG 80/10	2885	1652	1233	200	98
8LMG 80/11	3010	1777	1233	200	106
8LMG 80/12	3205	1902	1303	214	114
8LMG 80/13	3330	2027	1303	214	122
8LMG 80/14	3535	2152	1383	230	131
8LMG 80/15	3660	2277	1383	230	139

Max Eff. % =	70
Max kW / St. =	5,1

Q (flow)	25%	50%	75%	100%
NPSH (m)	3	3	3,5	4,5

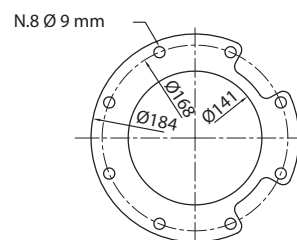
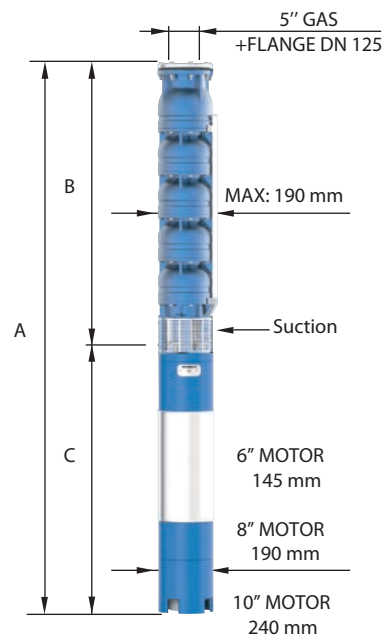

FOR COMMERCIAL TUBE
EXTERNAL DIAMETER: 139,7 mm

Tolleranza alla sabbia 50 g/m³ - sand tolerance 50 g/m³
Tolleranze secondo UNI ISO 9906 livello 3B - Tolerances according to UNI ISO 9906 grade 3B



8" 8LMG 80

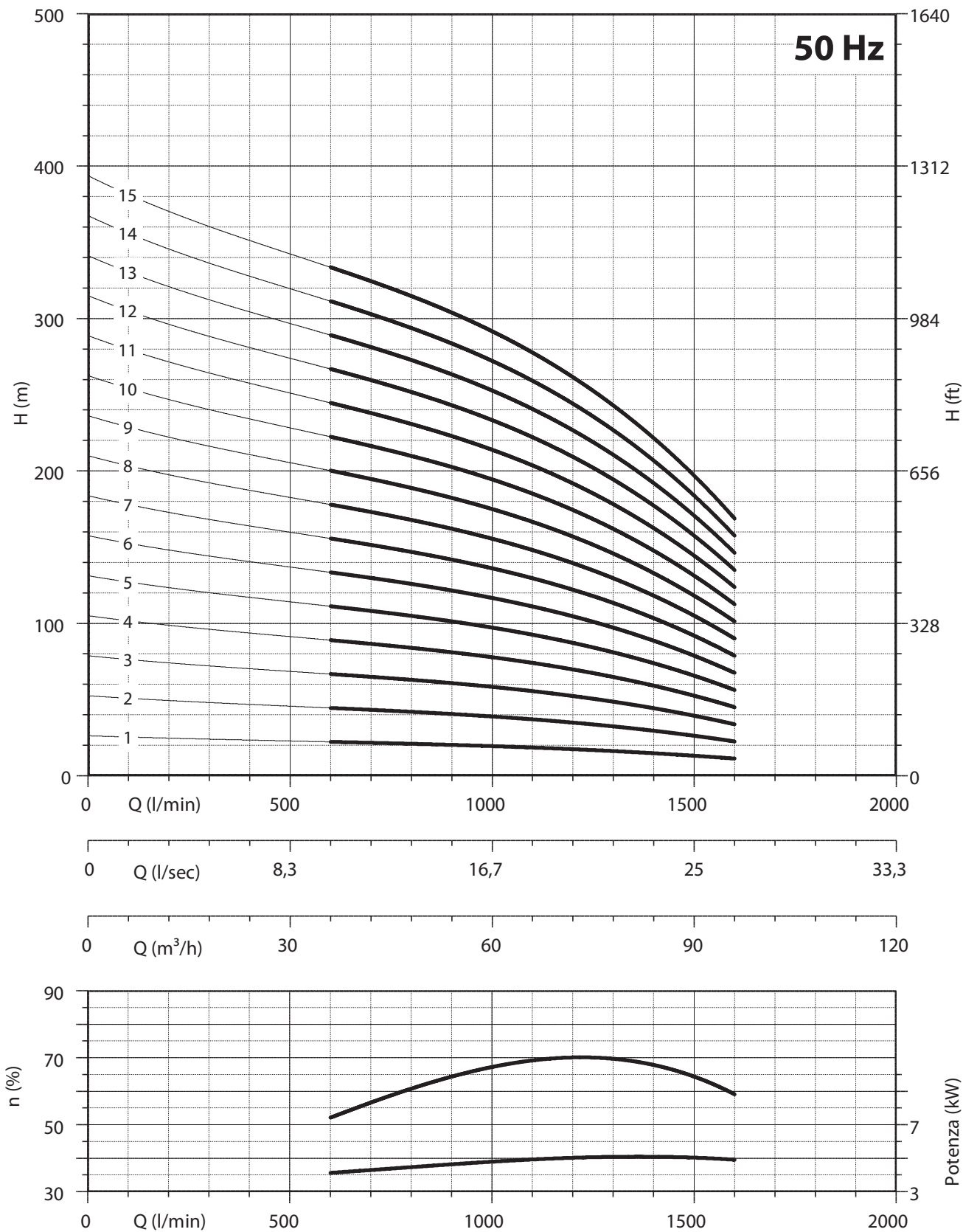

Tolleranza alla sabbia 50 g/m³ - sand tolerance 50 g/m³
 Tolleranze secondo UNI ISO 9906 livello 3B - Tolerances according to UNI ISO 9906 grade 3B



8" 8LMG 92

Motor 50 Hz - 2900 rpm				Q								
TYPE	Power		400 V	l/min	0	800	1000	1200	1400	1600	1800	2000
	(HP)	(kW)	A	l/sec	0	13,33	16,67	20,00	23,33	26,67	30,00	33,33
				m³/h	0	48	60	72	84	96	108	120
8LMG 92/01	10	7,5	17,5	H[m]	26	22	21	20	18	15	13	10
8LMG 92/02	17,5	13	28		53	44	42	39	35	31	25	20
8LMG 92/03	25	18,5	40		79	66	63	59	53	46	38	29
8LMG 92/04	35	26	55		105	89	84	78	70	61	50	39
8LMG 92/05	40	30	62,5		131	111	104	98	88	76	63	49
8LMG 92/06	50	37	78		158	133	125	117	105	92	75	59
8LMG 92/07	60	45	92		184	155	146	137	123	107	88	68
8LMG 92/08	75	55	113,5		210	177	167	156	140	122	100	78
8LMG 92/09	75	55	113,5		236	199	188	176	158	137	113	88
8LMG 92/10	90	66	134,5		263	221	209	195	175	153	125	98
8LMG 92/11	90	66	134,5		289	243	230	215	193	168	138	107
8LMG 92/12	100	75	149,5		315	266	251	234	210	183	150	117
8LMG 92/13	100	75	149,5		341	288	271	254	228	198	163	127
8LMG 92/14	125	92	185		368	310	292	273	245	214	175	137
8LMG 92/15	125	92	185		394	332	313	293	263	229	188	146

Motor 50 Hz 2900 rpm	Dimensions (mm)			Weight (kg)	
TYPE	A	B	C	M	P
8LMG 92/01	1228	527	701	55	23
8LMG 92/02	1493	652	841	70	31
8LMG 92/03	1768	777	991	83	39
8LMG 92/04	2083	902	1181	100	48
8LMG 92/05	2278	1027	1251	108	56
8LMG 92/06	2493	1152	1341	118	64
8LMG 92/07	2400	1277	1123	178	73
8LMG 92/08	2635	1402	1233	200	81
8LMG 92/09	2760	1527	1233	200	89
8LMG 92/10	2955	1652	1303	214	98
8LMG 92/11	3080	1777	1303	214	106
8LMG 92/12	3285	1902	1383	230	114
8LMG 92/13	3410	2027	1383	230	122
8LMG 92/14	3735	2152	1583	270	131
8LMG 92/15	3860	2277	1583	270	139

Max Eff. % =	70
Max kW / St. =	5,9

Q (flow)	25%	50%	75%	100%
NPSH (m)	3	4	5	8

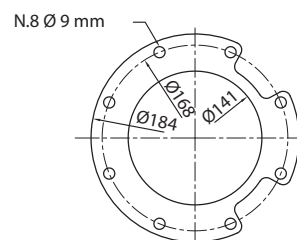
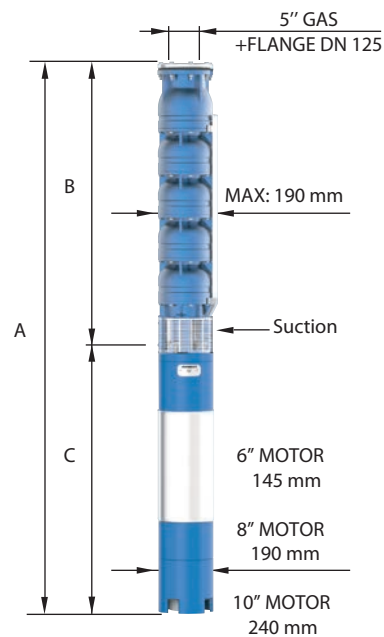

FOR COMMERCIAL TUBE
EXTERNAL DIAMETER: 139,7 mm

Tolleranza alla sabbia 50 g/m³ - sand tolerance 50 g/m³
Tolleranze secondo UNI ISO 9906 livello 3B - Tolerances according to UNI ISO 9906 grade 3B



8" 8LMG 92

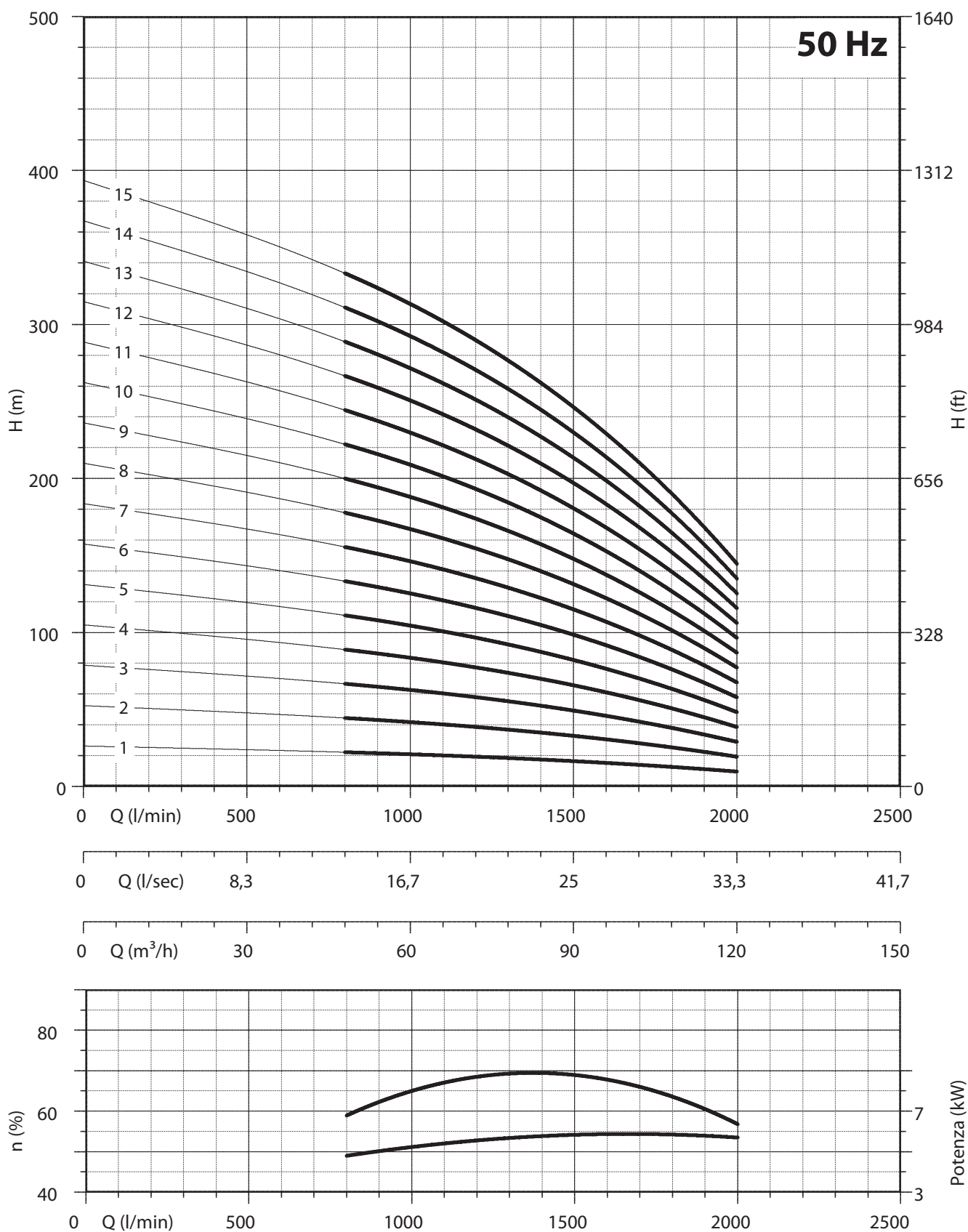

Tolleranza alla sabbia 50 g/m³ - sand tolerance 50 g/m³

Tolleranze secondo UNI ISO 9906 livello 3B - Tolerances according to UNI ISO 9906 grade 3B



8" 8LMG 110

Motor 50 Hz - 2900 rpm				Q									
TYPE	Power		400 V	l/min	0	1000	1200	1400	1600	1800	2000	2200	2400
	(HP)	(kW)	A	l/sec	0	16,67	20,00	23,33	26,67	30,00	33,33	36,67	40,00
				m ³ /h	0	60	72	84	96	108	120	132	144
8LMG 110/01	10	7,5	17,5	H[m]	26	22	21	20	19	18	16	14	11
8LMG 110/02	20	15	32		53	44	42	40	38	35	32	28	22
8LMG 110/03	30	22	47,5		79	66	63	60	57	53	48	42	33
8LMG 110/04	40	30	62,5		105	87	84	80	76	71	65	55	45
8LMG 110/05	50	37	78		131	109	105	100	95	89	81	69	56
8LMG 110/06	60	45	92		158	131	126	120	114	106	97	83	67
8LMG 110/07	75	55	113,5		184	153	147	140	133	124	113	97	78
8LMG 110/08	90	66	134,5		210	175	168	160	152	142	129	111	89
8LMG 110/09	90	66	134,5		237	197	189	180	171	159	145	125	100
8LMG 110/10	100	75	149,5		263	219	210	200	190	177	161	139	111
8LMG 110/11	125	92	185		289	240	231	220	209	195	178	152	123
8LMG 110/12	125	92	185		315	262	252	240	228	213	194	166	134
8LMG 110/13	125	92	185		342	284	273	260	247	230	210	180	145

Motor 50 Hz 2900 rpm	Dimensions (mm)			Weight (kg)	
TYPE	A	B	C	M	P
8LMG 110/01	1228	527	701	55	23
8LMG 110/02	1583	652	931	75	32
8LMG 110/03	1848	777	1071	92	40
8LMG 110/04	2153	902	1251	108	49
8LMG 110/05	2368	1027	1341	118	58
8LMG 110/06	2275	1152	1123	178	66
8LMG 110/07	2510	1277	1233	200	75
8LMG 110/08	2705	1402	1303	214	83
8LMG 110/09	2830	1527	1303	214	92
8LMG 110/10	3035	1652	1383	230	101
8LMG 110/11	3360	1777	1583	270	109
8LMG 110/12	3485	1902	1583	270	118
8LMG 110/13	3610	2027	1583	270	126

Max Eff. % =	74
Max kW / St. =	7,3

Q (flow)	25%	50%	75%	100%
NPSH (m)	2,5	3,5	4,5	8

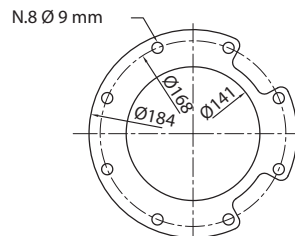
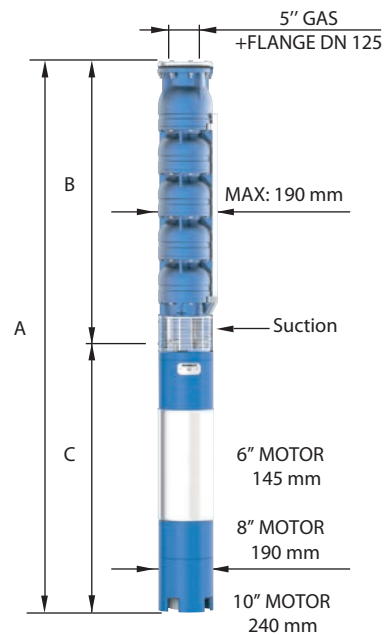

FOR COMMERCIAL TUBE
EXTERNAL DIAMETER: 139,7 mm

Tolleranza alla sabbia 50 g/m³ - sand tolerance 50 g/m³
Tolleranze secondo UNI ISO 9906 livello 3B - Tolerances according to UNI ISO 9906 grade 3B



8" 8LMG 110

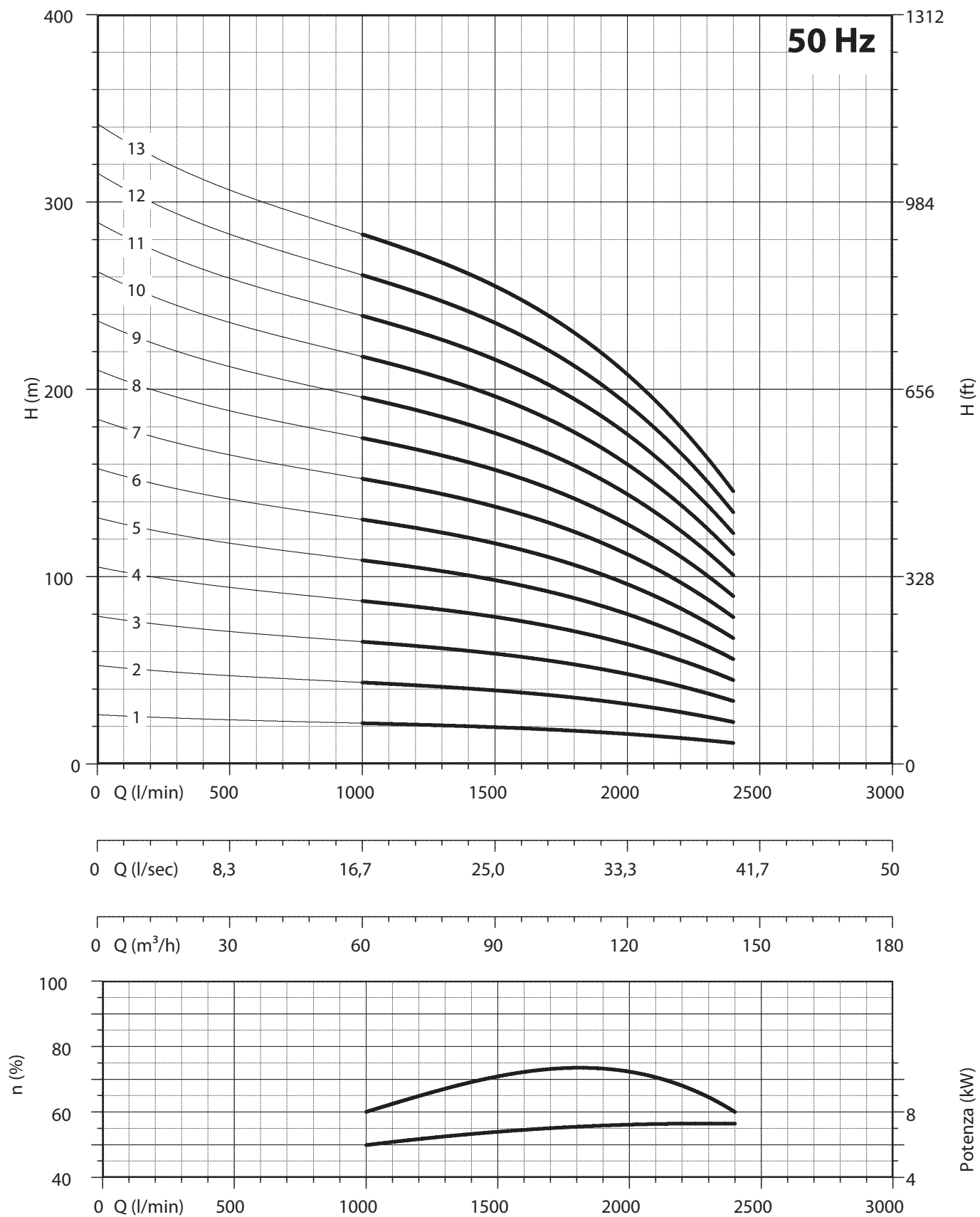

Tolleranza alla sabbia 50 g/m³ - sand tolerance 50 g/m³

Tolleranze secondo UNI ISO 9906 livello 3B - Tolerances according to UNI ISO 9906 grade 3B



8" 8LMG 130

Motor 50 Hz - 2900 rpm				Q										
TYPE	Power		400 V	l/min	0	1200	1400	1600	1800	2000	2200	2400	2600	2800
	(HP)	(kW)	A	l/sec	0	20,00	23,33	26,67	30,00	33,33	36,67	40,00	43,33	46,67
				m ³ /h	0	72	84	96	108	120	132	144	156	168
8LMG 130/01	10	7,5	17,5	H[m]	26	21	20	19	18	17	15	13	11	8
8LMG 130/02	20	15	32		53	42	41	38	36	34	31	27	21	15
8LMG 130/03	35	26	55		79	63	61	57	54	51	46	40	32	23
8LMG 130/04	40	30	62,5		106	85	81	77	73	67	62	54	43	30
8LMG 130/05	60	45	92		132	106	101	96	91	84	77	67	54	38
8LMG 130/06	75	55	113,5		159	127	122	115	109	101	93	81	64	45
8LMG 130/07	75	55	113,5		185	148	142	134	127	118	108	94	75	53
8LMG 130/08	90	66	134,5		211	169	162	153	145	135	123	107	86	61
8LMG 130/09	100	75	149,5		238	190	183	172	163	152	139	121	96	68
8LMG 130/10	100	75	149,5		264	211	203	191	181	169	154	134	107	76
8LMG 130/11	125	92	185		291	233	223	211	200	185	170	148	118	83
8LMG 130/12	125	92	185		317	254	243	230	218	202	185	161	129	91
8LMG 130/13	150	110	219		344	275	264	249	236	219	201	175	139	98
8LMG 130/14	150	110	220		370	296	284	268	254	236	216	188	150	106

Motor 50 Hz 2900 rpm	Dimensions (mm)			Weight (kg)	
TYPE	A	B	C	M	P
8LMG 130/01	1228	527	701	55	23
8LMG 130/02	1583	652	931	75	32
8LMG 130/03	1958	777	1181	100	41
8LMG 130/04	2153	902	1251	108	49
8LMG 130/05	2150	1027	1123	178	58
8LMG 130/06	2385	1152	1233	200	67
8LMG 130/07	2510	1277	1233	200	75
8LMG 130/08	2705	1402	1303	214	84
8LMG 130/09	2910	1527	1383	230	93
8LMG 130/10	3035	1652	1383	230	102
8LMG 130/11	3360	1777	1583	270	110
8LMG 130/12	3485	1902	1583	270	119
8LMG 130/13	3760	2027	1733	300	128
8LMG 130/14	3885	2152	1733	300	136

Max Eff. % =	75
Max kW / St. =	7,7

Q (flow)	25%	50%	75%	100%
NPSH (m)	2,5	3	5	9

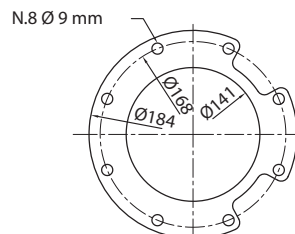
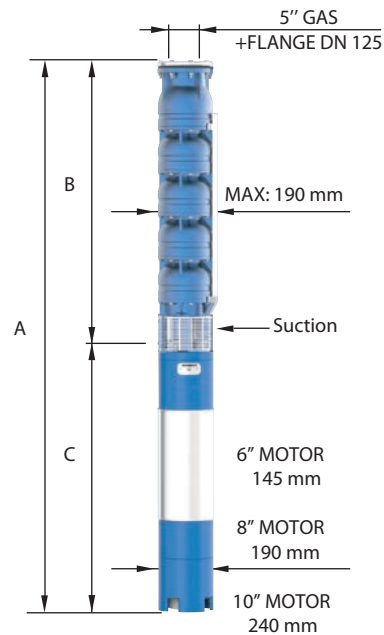

FOR COMMERCIAL TUBE
EXTERNAL DIAMETER: 139,7 mm

Tolleranza alla sabbia 50 g/m³ - sand tolerance 50 g/m³
Tolleranze secondo UNI ISO 9906 livello 3B - Tolerances according to UNI ISO 9906 grade 3B



8" 8LMG 130

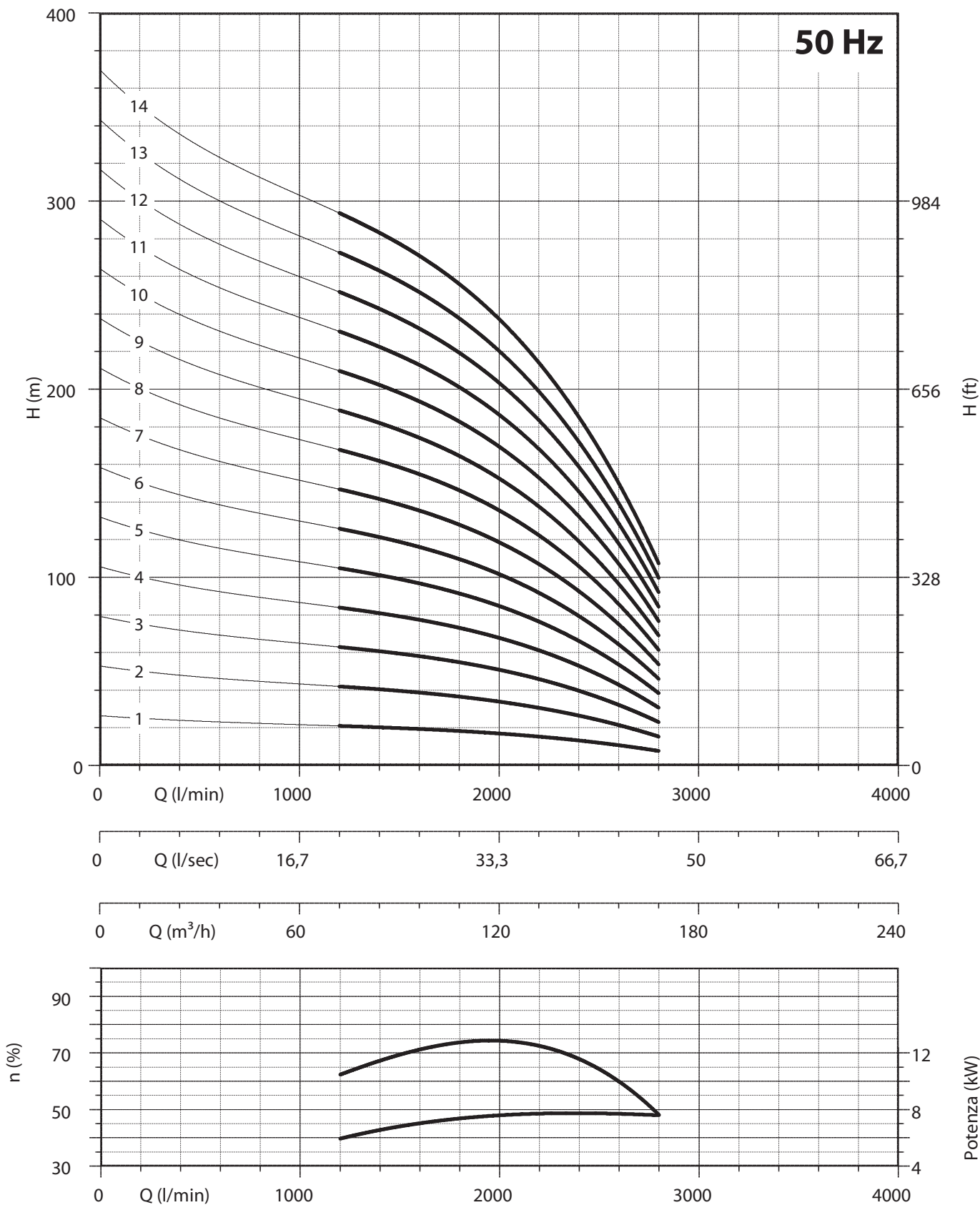

Tolleranza alla sabbia 50 g/m³ - sand tolerance 50 g/m³
 Tolleranze secondo UNI ISO 9906 livello 3B - Tolerances according to UNI ISO 9906 grade 3B



8" 8LMG 160

Motor 50 Hz - 2900 rpm				Q										
TYPE	Power		400 V	l/min l/sec	0	1600	1800	2000	2200	2400	2600	2800	3000	3200
	(HP)	(kW)			A	0	26,67	30,00	33,33	36,67	40,00	43,33	46,67	50,00
				m ³ /h	0	96	108	120	132	144	156	168	180	192
8LMG 160/01	12,5	9,2	21	H[m]	24	19	18	17	16	16	15	13	12	10
8LMG 160/02	25	18,5	40		49	38	36	35	33	31	30	27	24	20
8LMG 160/03	35	26	55		73	57	54	52	49	47	45	40	36	30
8LMG 160/04	50	37	78		97	76	72	69	66	63	59	54	48	40
8LMG 160/05	60	45	92		121	95	90	86	82	79	74	67	60	50
8LMG 160/06	75	55	113,5		146	114	108	104	99	94	89	81	72	60
8LMG 160/07	90	66	134,5		170	133	126	121	115	110	104	94	84	70
8LMG 160/08	100	75	149,5		194	152	144	138	131	126	119	107	96	80
8LMG 160/09	100	75	149,5		219	171	162	156	148	141	134	121	108	90
8LMG 160/10	125	92	185		243	190	180	173	164	157	149	134	120	100
8LMG 160/11	125	92	185		267	209	198	190	181	173	163	148	132	110
8LMG 160/12	150	110	219		291	228	216	207	197	189	178	161	144	120
8LMG 160/13	150	110	219		316	247	234	225	214	204	193	175	156	130

Motor 50 Hz 2900 rpm	Dimensions (mm)			Weight (kg)	
TYPE	A	B	C	M	P
8LMG 160/01	1303	552	751	60	24
8LMG 160/02	1693	702	991	83	33
8LMG 160/03	2033	852	1181	100	42
8LMG 160/04	2343	1002	1341	118	51
8LMG 160/05	2275	1152	1123	178	60
8LMG 160/06	2535	1302	1233	200	69
8LMG 160/07	2755	1452	1303	214	78
8LMG 160/08	2985	1602	1383	230	87
8LMG 160/09	3135	1752	1383	230	96
8LMG 160/10	3485	1902	1583	270	105
8LMG 160/11	3635	2052	1583	270	114
8LMG 160/12	3935	2202	1733	300	123
8LMG 160/13	4085	2352	1733	300	132

Max Eff. % =	74
Max kW / St. =	8,6

Q (flow)	25%	50%	75%	100%
NPSH (m)	4	4,5	7	13

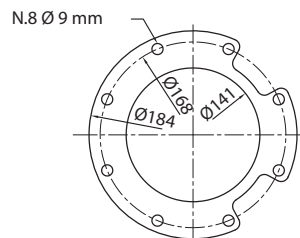
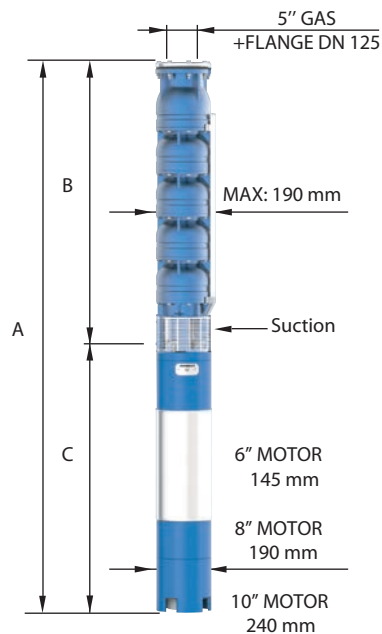

FOR COMMERCIAL TUBE
EXTERNAL DIAMETER: 139,7 mm

Tolleranza alla sabbia 50 g/m³ - sand tolerance 50 g/m³
Tolleranze secondo UNI ISO 9906 livello 3B - Tolerances according to UNI ISO 9906 grade 3B



8" 8LMG 160

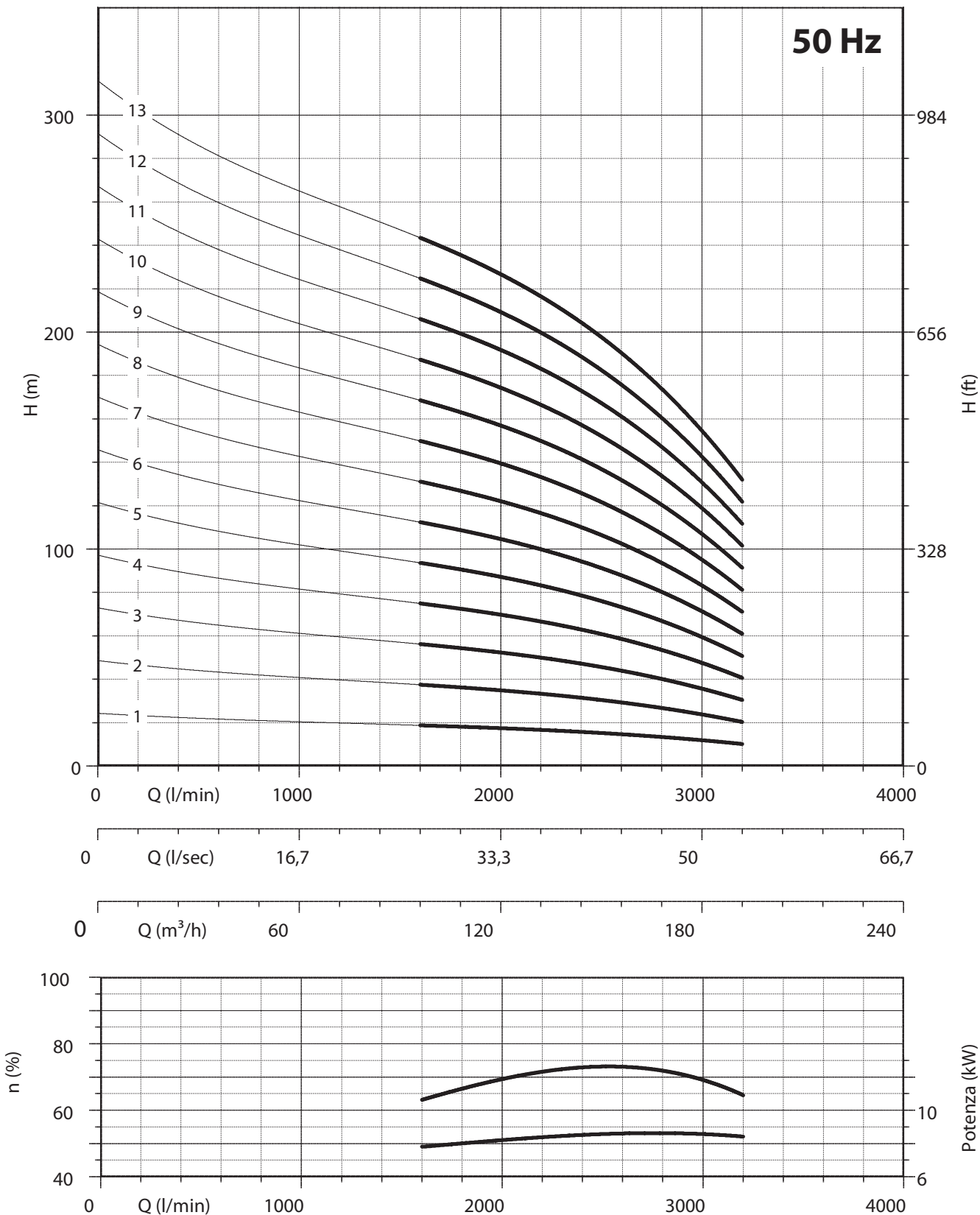

Tolleranza alla sabbia 50 g/m³ - sand tolerance 50 g/m³
 Tolleranze secondo UNI ISO 9906 livello 3B - Tolerances according to UNI ISO 9906 grade 3B



10" 10LMG 190

Motor 50 Hz - 2900 rpm				Q							
TYPE	Power		400 V	l/min	0	1800	2200	2600	3000	3400	3800
	(HP)	(kW)			0	30,00	36,67	43,33	50,00	56,67	63,33
			A	l/sec	0	108	132	156	180	204	228
10LMG 190/01 DR 20	20	15	32	H[m]	32	29	28	25	24	20	16
10LMG 190/01 DR 10	25	18,5	40		37	33	31	29	27	22	18
10LMG 190/01	30	22	47,5		42	37	35	32	30	25	20
10LMG 190/02 DR 20	40	30	62,5		65	58	55	50	48	40	32
10LMG 190/02 DR 10	50	37	78		73	66	62	57	54	45	36
10LMG 190/02	60	45	92		83	74	70	64	60	50	40
10LMG 190/03 DR 20	75	55	113,5		97	88	83	76	71	59	47
10LMG 190/03 DR 10	75	55	113,5		110	99	94	86	80	67	53
10LMG 190/03	90	66	134,5		125	111	105	96	90	75	60
10LMG 190/04 DR 20	90	66	134,5		130	117	110	101	95	79	63
10LMG 190/04 DR 10	100	75	149,5		146	132	125	114	107	90	71
10LMG 190/04	100	75	149,5		166	148	140	128	120	100	80
10LMG 190/05 DR 20	100	75	149,5		162	146	138	126	119	99	79
10LMG 190/05 DR 10	125	92	185		183	165	156	143	134	112	89
10LMG 190/05	150	110	219		208	185	175	160	150	125	100
10LMG 190/06 DR 20	125	92	185		194	175	166	151	143	119	95
10LMG 190/06 DR 10	150	110	219		220	198	187	172	161	134	107
10LMG 190/06	175	130	254,5		250	222	210	192	180	150	120
10LMG 190/07 DR 20	150	110	219		227	204	193	176	167	139	111
10LMG 190/07 DR 10	175	130	254,5		256	231	218	200	188	157	125
10LMG 190/07	200	150	290		291	259	245	224	210	175	140
10LMG 190/08 DR 20	175	130	254,5		259	234	221	202	190	158	126
10LMG 190/08 DR 10	200	150	290		293	264	250	229	214	179	142
10LMG 190/08	225	165	330		333	296	280	256	240	200	160

Motor 50 Hz 2900 rpm	Dimensions (mm)			Weight (kg)	
TYPE	A	B	C	M	P
10LMG 190/01 DR 20	1556	625	931	75	50
10LMG 190/01 DR 10	1616	625	991	83	50
10LMG 190/01	1696	625	1071	92	50
10LMG 190/02 DR 20	2056	805	1251	108	68
10LMG 190/02 DR 10	2146	805	1341	118	68
10LMG 190/02	1928	805	1123	178	68
10LMG 190/03 DR 20	2218	985	1233	200	87
10LMG 190/03 DR 10	2218	985	1233	200	87
10LMG 190/03	2288	985	1303	214	87
10LMG 190/04 DR 20	2468	1165	1303	214	105
10LMG 190/04 DR 10	2548	1165	1383	230	105
10LMG 190/04	2548	1165	1383	230	105
10LMG 190/05 DR 20	2728	1345	1383	230	124
10LMG 190/05 DR 10	2928	1345	1583	270	124
10LMG 190/05	3078	1345	1733	300	124
10LMG 190/06 DR 20	3108	1525	1583	270	142
10LMG 190/06 DR 10	3258	1525	1733	300	142
10LMG 190/06	3159	1525	1634	385	142
10LMG 190/07 DR 20	3438	1705	1733	300	161
10LMG 190/07 DR 10	3339	1705	1634	385	161
10LMG 190/07	3439	1705	1734	415	161
10LMG 190/08 DR 20	3519	1885	1634	385	179
10LMG 190/08 DR 10	3619	1885	1734	415	179
10LMG 190/08	3739	1885	1854	444	179

Max Eff. % DR20 =	74
Max Eff. % DR10 =	75
Max Eff. % =	75,5
Max kW / St. DR20 =	15,7
Max kW / St. DR10 =	17,5
Max kW / St. =	19,4

Q (flow)	25%	50%	75%	100%
NPSH (m)	3,6	5,3	8,1	14

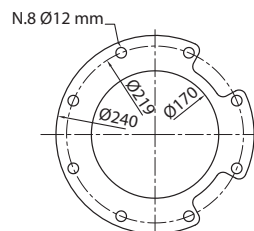
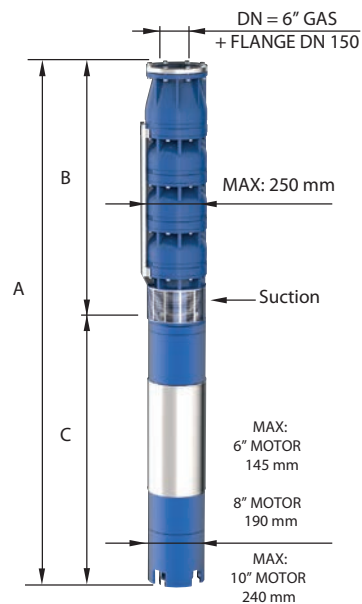

FOR COMMERCIAL TUBE
EXTERNAL DIAMETER: 168,3 mm

Tolleranza alla sabbia 50 g/m³ - sand tolerance 50 g/m³

Tolleranze secondo UNI ISO 9906 livello 3B - Tolerances according to UNI ISO 9906 grade 3B



10" 10LMG 190

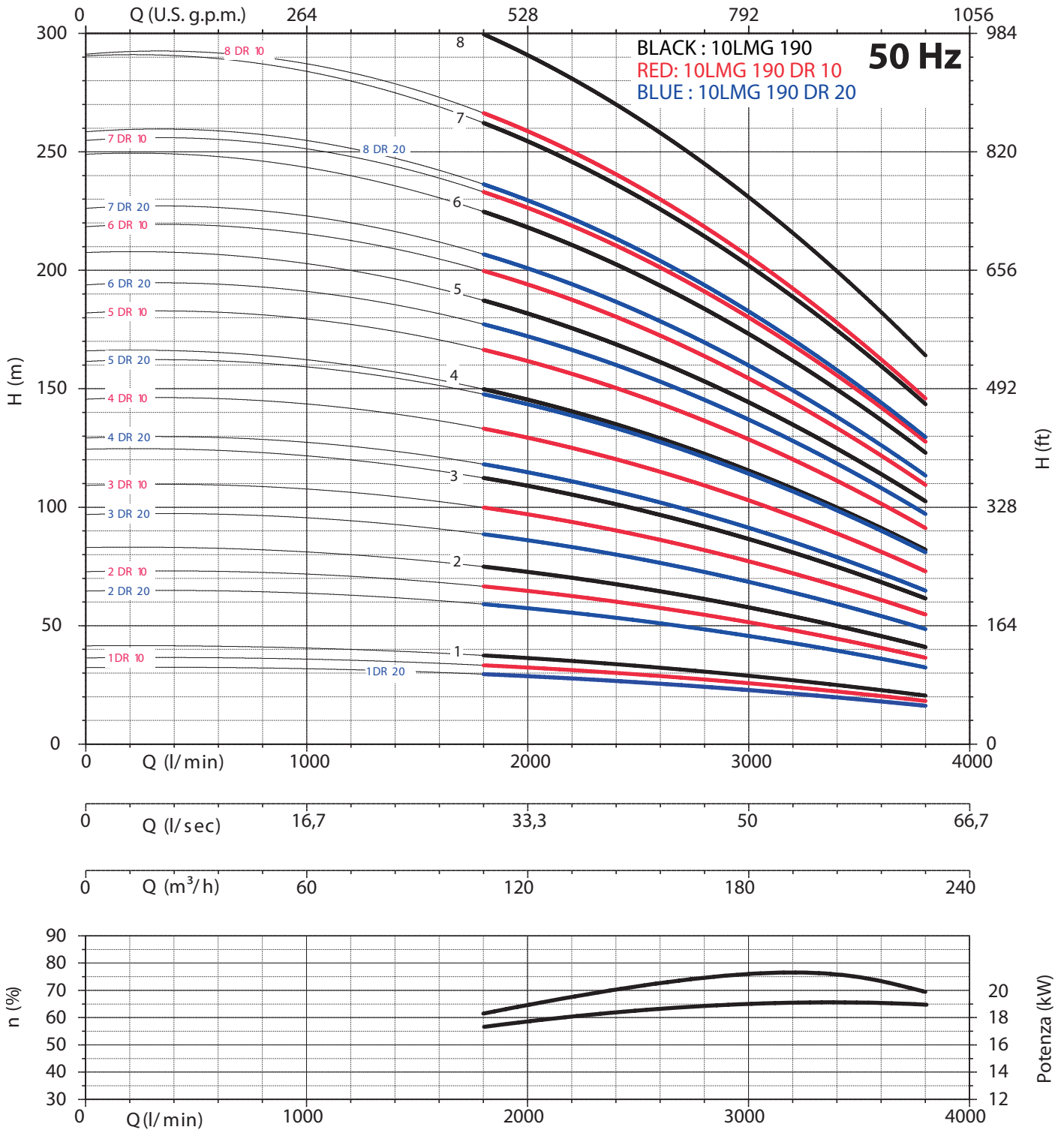

Tolleranza alla sabbia 50 g/m³ - sand tolerance 50 g/m³

Tolleranze secondo UNI ISO 9906 livello 3B - Tolerances according to UNI ISO 9906 grade 3B



10" 10LMG 230

Motor 50 Hz - 2900 rpm				Q								
TYPE	Power		400 V	l/min l/sec m ³ /h	0	2200	2600	3000	3400	3800	4200	4400
	(HP)	(kW)			0	36,67	43,33	50,00	56,67	63,33	70,00	73,33
	A		0	132	156	180	204	228	252	264		
10LMG 230/01 DR 20	25	18,5	40	H[m]	34	29	28	26	24	22	19	16
10LMG 230/01 DR 10	30	22	47,5		38	33	31	29	27	25	21	17
10LMG 230/01	30	22	47,5		43	37	35	33	30	28	24	22
10LMG 230/02 DR 20	50	37	78		68	58	55	52	48	44	38	33
10LMG 230/02 DR 10	60	45	92		77	66	62	59	54	50	43	35
10LMG 230/02	60	45	92		86	74	70	66	60	56	48	44
10LMG 230/03 DR 20	75	55	113,5		102	88	83	78	71	67	57	49
10LMG 230/03 DR 10	90	66	134,5		115	99	94	88	80	75	64	52
10LMG 230/03	100	75	149,5		129	111	105	99	90	84	72	66
10LMG 230/04 DR 20	100	75	149,5		136	117	110	104	95	89	76	66
10LMG 230/04 DR 10	125	92	185		154	132	125	118	107	100	86	70
10LMG 230/04	125	92	185		172	148	140	132	120	112	96	88
10LMG 230/05 DR 20	125	92	185		170	146	138	130	119	111	95	82
10LMG 230/05 DR 10	150	110	219		192	165	156	147	134	125	107	87
10LMG 230/05	175	130	254,5		215	185	175	165	150	140	120	110
10LMG 230/06 DR 20	150	110	219		204	175	166	156	143	133	114	98
10LMG 230/06 DR 10	175	130	254,5		230	198	187	176	161	150	128	104
10LMG 230/06	200	150	290		258	222	210	198	180	168	144	132
10LMG 230/07 DR 20	175	130	254,5		238	204	193	182	167	155	133	115
10LMG 230/07 DR 10	200	150	290		269	231	218	206	188	175	150	122
10LMG 230/07	225	165	330	301	259	245	231	210	196	168	154	

Motor 50 Hz 2900 rpm	Dimensions (mm)			Weight (kg)	
TYPE	A	B	C	M	P
10LMG 230/01 DR 20	1616	625	991	83	50
10LMG 230/01 DR 10	1696	625	1071	92	50
10LMG 230/01	1696	625	1071	92	50
10LMG 230/02 DR 20	2146	805	1341	118	68
10LMG 230/02 DR 10	1928	805	1123	178	68
10LMG 230/02	1928	805	1123	178	68
10LMG 230/03 DR 20	2218	985	1233	200	87
10LMG 230/03 DR 10	2288	985	1303	214	87
10LMG 230/03	2368	985	1383	230	87
10LMG 230/04 DR 20	2548	1165	1383	230	105
10LMG 230/04 DR 10	2748	1165	1583	270	105
10LMG 230/04	2748	1165	1583	270	105
10LMG 230/05 DR 20	2928	1345	1583	270	124
10LMG 230/05 DR 10	3078	1345	1733	300	124
10LMG 230/05	2979	1345	1634	385	124
10LMG 230/06 DR 20	3258	1525	1733	300	142
10LMG 230/06 DR 10	3159	1525	1634	385	142
10LMG 230/06	3259	1525	1734	415	142
10LMG 230/07 DR 20	3339	1705	1634	385	161
10LMG 230/07 DR 10	3439	1705	1734	415	161
10LMG 230/07	3559	1705	1854	444	161

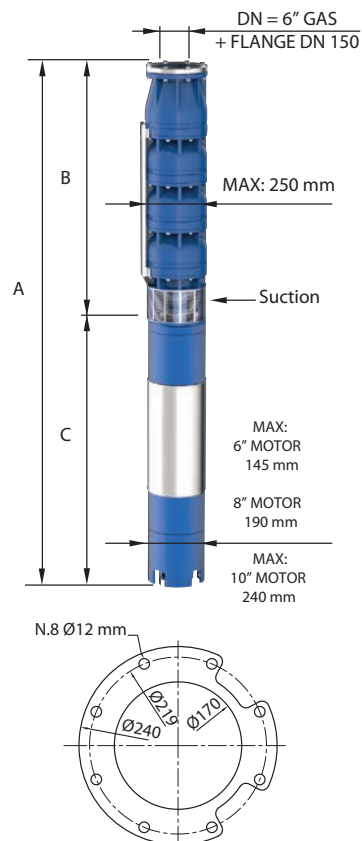

FOR COMMERCIAL TUBE
EXTERNAL DIAMETER: 168,3 mm

Max Eff. % DR20 =	75,5
Max Eff. % DR10 =	76
Max Eff. % =	76,5
Max kW / St. DR20 =	18,3
Max kW / St. DR10 =	20,5
Max kW / St. =	23

Q (flow)	25%	50%	75%	100%
NPSH (m)	3,7	5,4	8,3	14,2

Tolleranza alla sabbia 50 g/m³ - sand tolerance 50 g/m³
Tolleranze secondo UNI ISO 9906 livello 3B - Tolerances according to UNI ISO 9906 grade 3B



10" 10LMG 230

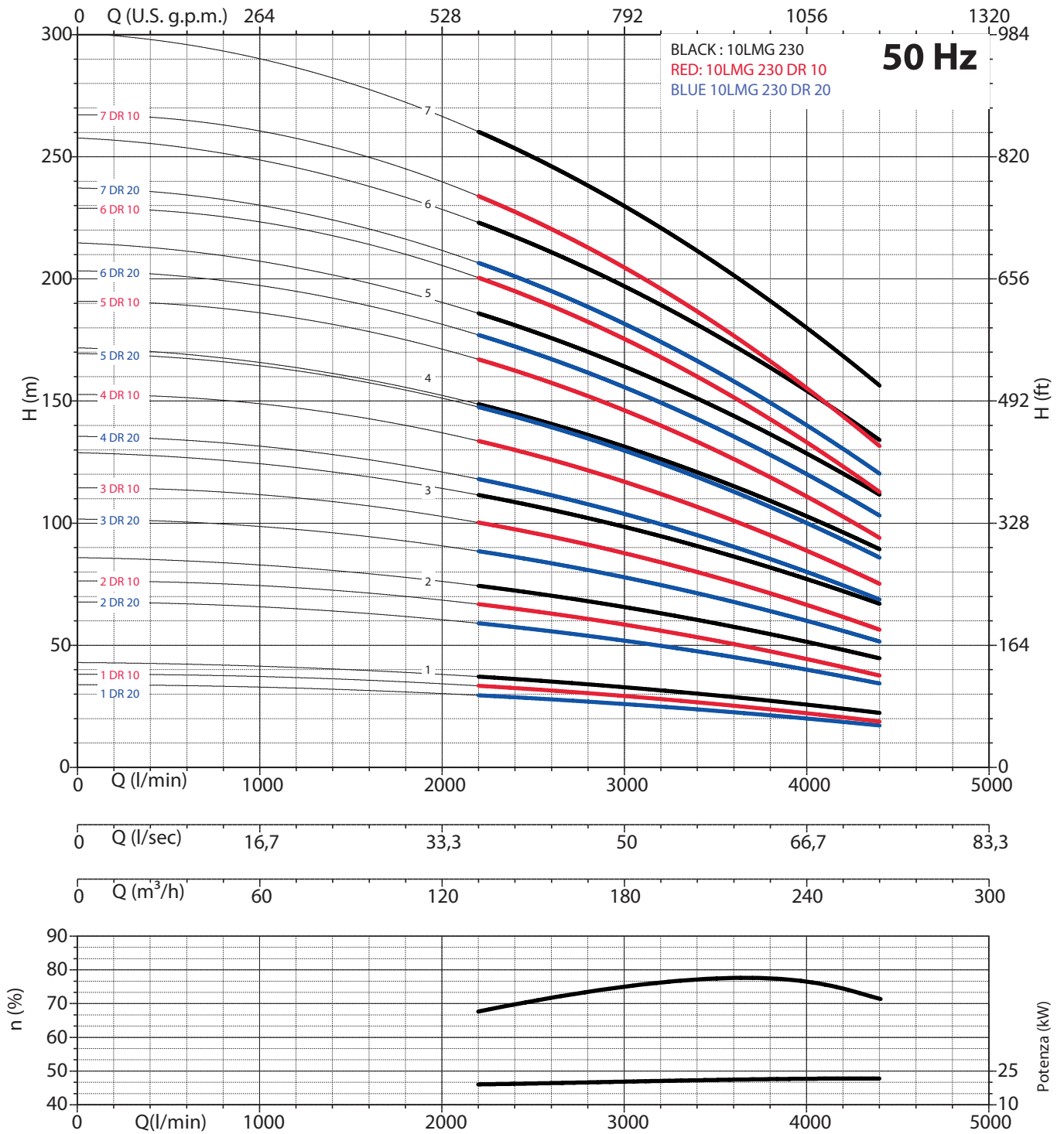

Tolleranza alla sabbia 50 g/m³ - sand tolerance 50 g/m³

Tolleranze secondo UNI ISO 9906 livello 3B - Tolerances according to UNI ISO 9906 grade 3B



10" 10LMG 250

Motor 50 Hz - 2900 rpm				Q									
TYPE	Power		400 V	l/min	0	2400	2800	3200	3600	4000	4400	4800	5000
	(HP)	(kW)			0	40,00	46,67	53,33	60,00	66,67	73,33	80,00	83,33
	A	m³/h	0	144	168	192	216	240	264	288	300		
10LMG 250/01 DR 20	30	22	47,5	H[m]	34	28	27	26	25	22	21	18	17
10LMG 250/01 DR 10	35	26	55		38	32	30	29	28	25	23	20	20
10LMG 250/01	35	26	55		43	36	34	33	31	28	26	23	22
10LMG 250/02 DR 20	60	45	92		68	57	54	52	49	44	41	36	35
10LMG 250/02 DR 10	75	55	113,5		77	64	61	59	55	50	46	41	39
10LMG 250/02	75	55	113,5		86	72	68	66	62	56	52	46	44
10LMG 250/03 DR 20	90	66	134,5		102	85	81	79	74	67	62	55	52
10LMG 250/03 DR 10	100	75	149,5		115	96	91	88	83	75	70	61	59
10LMG 250/03	125	92	185		129	108	102	99	93	84	78	69	66
10LMG 250/04 DR 20	125	92	185		136	114	108	105	98	89	82	73	70
10LMG 250/04 DR 10	125	92	185		154	128	122	118	110	100	93	82	78
10LMG 250/04	150	110	219		172	144	136	132	124	112	104	92	88
10LMG 250/05 DR 20	150	110	219		170	142	135	131	123	111	103	91	87
10LMG 250/05 DR 10	175	130	254,5		192	160	152	147	138	125	116	102	98
10LMG 250/05	175	130	254,5		215	180	170	165	155	140	130	115	110
10LMG 250/06 DR 20	175	130	254,5		204	170	162	157	148	133	124	109	104
10LMG 250/06 DR 10	200	150	290		230	192	182	176	166	150	139	122	118
10LMG 250/06	225	165	330		258	216	204	198	186	168	156	138	132
10LMG 250/07 DR 20	225	165	330		238	199	189	183	172	155	144	127	122
10LMG 250/07 DR 10	225	165	330		269	224	213	206	193	175	162	143	137

Motor 50 Hz 2900 rpm	Dimensions (mm)			Weight (kg)	
TYPE	A	B	C	M	P
10LMG 250/01 DR 20	1696	625	1071	92	50
10LMG 250/01 DR 10	1806	625	1181	100	50
10LMG 250/01	1806	625	1181	100	50
10LMG 250/02 DR 20	1928	805	1123	178	68
10LMG 250/02 DR 10	2038	805	1233	200	68
10LMG 250/02	2038	805	1233	200	68
10LMG 250/03 DR 20	2288	985	1303	214	87
10LMG 250/03 DR 10	2368	985	1383	230	87
10LMG 250/03	2568	985	1583	270	87
10LMG 250/04 DR 20	2748	1165	1583	270	105
10LMG 250/04 DR 10	2748	1165	1583	270	105
10LMG 250/04	2898	1165	1733	300	105
10LMG 250/05 DR 20	3078	1345	1733	300	124
10LMG 250/05 DR 10	2979	1345	1634	385	124
10LMG 250/05	2979	1345	1634	385	124
10LMG 250/06 DR 20	3159	1525	1634	385	142
10LMG 250/06 DR 10	3259	1525	1734	415	142
10LMG 250/06	3379	1525	1854	444	142
10LMG 250/07 DR 20	3559	1705	1854	444	161
10LMG 250/07 DR 10	3559	1705	1854	444	161

Max Eff. % DR20 =	75,5
Max Eff. % DR10 =	76
Max Eff. % =	76,5
Max kW / St. DR20 =	21,9
Max kW / St. DR10 =	23,5
Max kW / St. =	26,3

Q (flow)	25%	50%	75%	100%
NPSH (m)	3,9	5,5	8,5	14,4

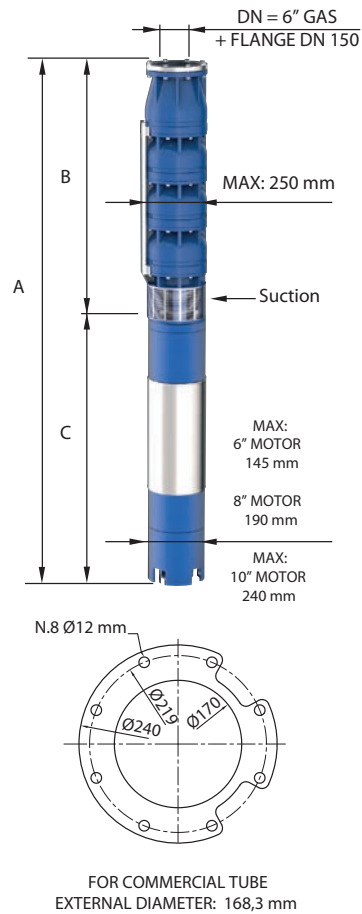

Tolleranza alla sabbia 50 g/m³ - sand tolerance 50 g/m³
Tolleranze secondo UNI ISO 9906 livello 3B - Tolerances according to UNI ISO 9906 grade 3B

10" 10LMG 250

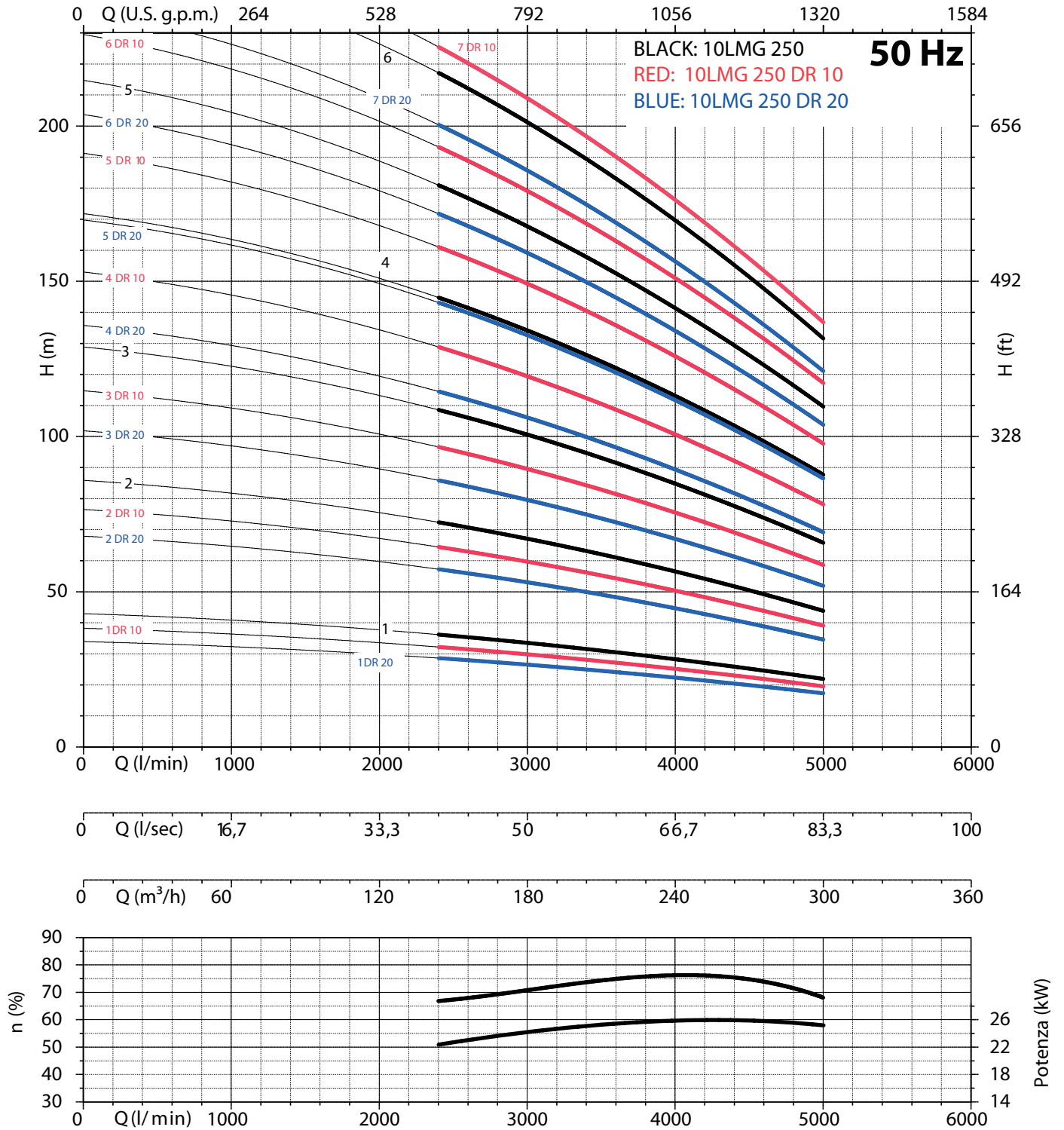

Tolleranza alla sabbia 50 g/m³ - sand tolerance 50 g/m³

Tolleranze secondo UNI ISO 9906 livello 3B - Tolerances according to UNI ISO 9906 grade 3B



6"-8"-10" - 6LMG, 8LMG, 10LMG lines

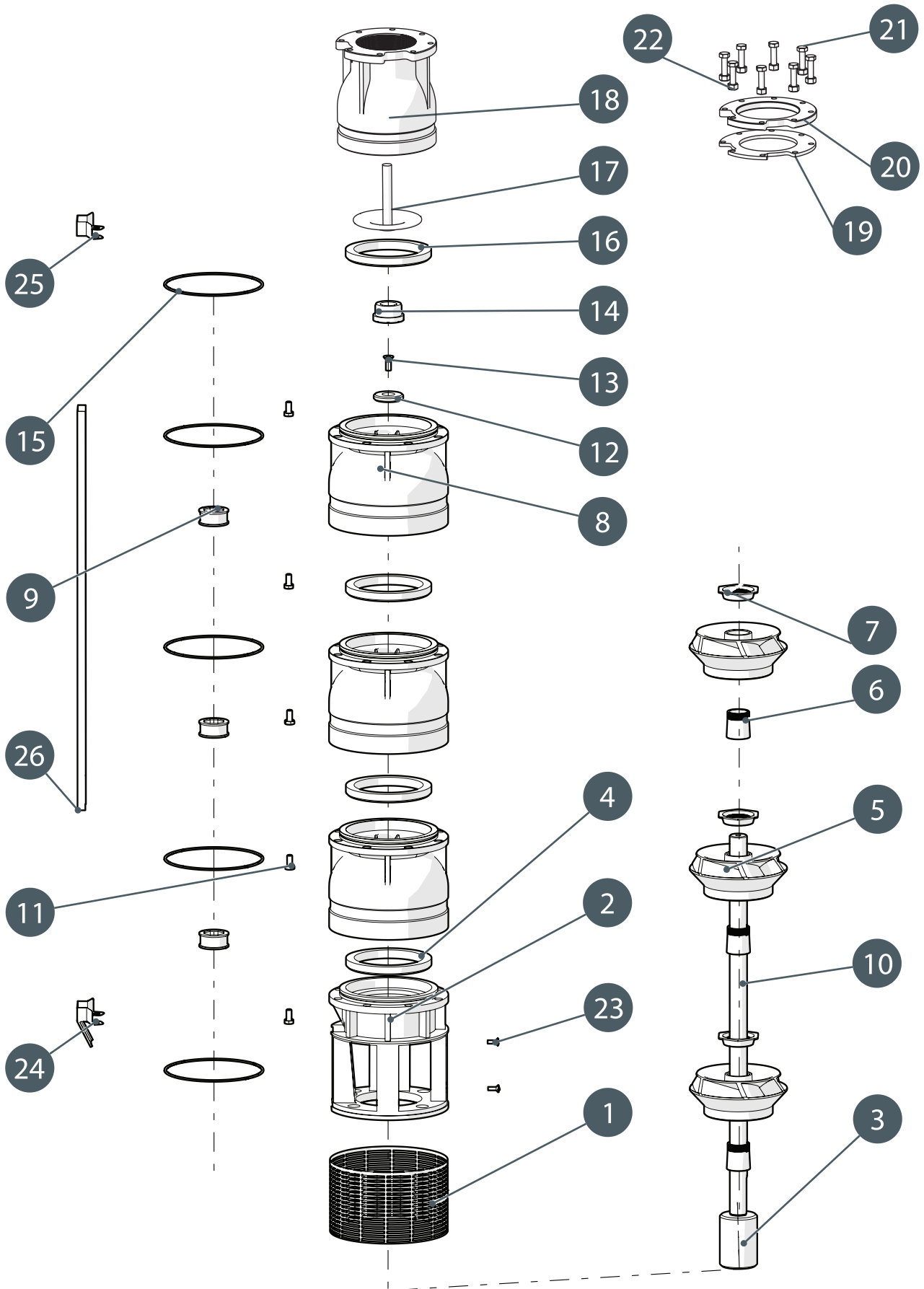

6"-8"-10" - 6LMG, 8LMG, 10LMG lines

6LMG, 8LMG, 10LMG lines			
N. CODE	DESCRIZIONE (ITALIANO)	DESCRIPTION (ENGLISH)	MATERIAL
1	SUCCHERUOLA	SUCTION STRAINER	AISI 304
2	GABBIA DI ASPIRAZIONE	SUCTION CAGE	CAST IRON
3	GIUNTO	JOINT	AISI 304
4	ANELLO USURA	USURY RING	NBR
5	GIRANTE	IMPELLER	CAST IRON
6	CONO	CONE	AISI 304
7	GHIERA	HEXAGONAL RING	AISI 304
8	DIFFUSORE	DIFFUSEUR	AISI 304
9	BRONZINA	BEARING BUSH	NBR
10	ALBERO POMPA	PUMP SHAFT	AISI 304
11	N.8 VITI PER DIFFUSORE	N.8 SCREW FOR DIFFUSEUR	AISI 304
12	DISCO ACCIAIO	RING	AISI 304
13	VITE DISCO ACCIAIO	SCREW FOR DISK	AISI 304
14	CONTROSOSPENSIONE	COUNTERTHRUST	PTFE + 25% CARBON
15	O-RING	O-RING	NBR
16	GUARNIZIONE FARFALLA	GASKET VALVE	NBR
17	FARFALLA	CAP VALVE	AISI 304
18	CORPO VALVOLA	BODY VALVE	CAST IRON
19	GUARNIZIONE CONTROFLANGIA	SEAL COUNTERFLANGE	NBR
20	CONTROFLANGIA	COUNTERFLANGE	IRON
21	N.8 VITI PER CONTROFLANGIA	N.8 SCREW FOR COUNTERFLANGE	AISI 304
22	N.8 DADI PER CONTROFLANGIA	N.8 NUT FOR COUNTERFLANGE	AISI 304
23	N.2 VITI PER SUCCHERUOLA	N.2 SCREW FOR SUCTION STRAINER	AISI 304
24	STAFFETTA INFERIORE	LOWER FLANGE	AISI 304
25	STAFFETTA SUPERIORE	UPPER FLANGE	AISI 304
26	COPRICAVO	COVER CABLE	AISI 304

N. CODE	DESCRIPTION (FRANCAIS)	DESCRIPTION (ESPAÑOL)	MATERIAL
1	CREPINE	REJILLA	AISI 304
2	CAGE D'ASPIRATION	CUERPO DE ASPIRACION	CAST IRON
3	JOINT	ACOPLAMIENTO	AISI 304
4	BAGUE D'USURE	ANILLO DE DESGASTE	NBR
5	ROUE	IMPULSOR	CAST IRON
6	CONE	CONO	AISI 304
7	BAGUE	ANILLO HEXAGONAL	AISI 304
8	DIFFUSEUR	DIFUSOR	CAST IRON
9	COUSSINET	COJINETE	NBR
10	ABRE POMPE	EJE DE BOMBA	AISI 304
11	N.8 VIS POUR DIFFUSEUR	N.8 TORNILLOS DIFUSOR	AISI 304
12	RING	ANILLO EN ACERO	AISI 304
13	VIS RING	TORNILLO POR ANILLO EN ACERO	AISI 304
14	CONTRESUSPENSION	CONTRA-SUSPENCION	PTFE + 25% CARBON
15	O-RING	ANILLO TORICO	NBR
16	GASKET VALVE	JUNTA DE VALVULA	NBR
17	PLAT	VALVULA	AISI 304
18	CORPS DE VALVE	CUERPO DE IMPULSION	CAST IRON
19	JOINT ETANCHEITE CONTREBRIDE	JUNTA CONTRE-BRIDA	NBR
20	CONTREBRIDE	CONTRE-BRIDA	IRON
21	N.8 VIS POUR CONTREBRIDE	N. 8 TORNILLOS CONTRE-BRIDA	AISI 304
22	N.8 ECROU POUR CONTREBRIDE	N. 8 TUERCAS CONTRE-BRIDA	AISI 304
23	N.2 VIS POUR CREPINE	N.2 TORNILLOS REJILLA	AISI 304
24	BRIDE INFERIEURE	GRAPA INFERIOR	AISI 304
25	BRIDE SUPERIEURE	GRAPA SUPERIOR	AISI 304
26	PROTECTOR CABLE	PARACABLE	AISI 304

