

PUMP  **TECH**

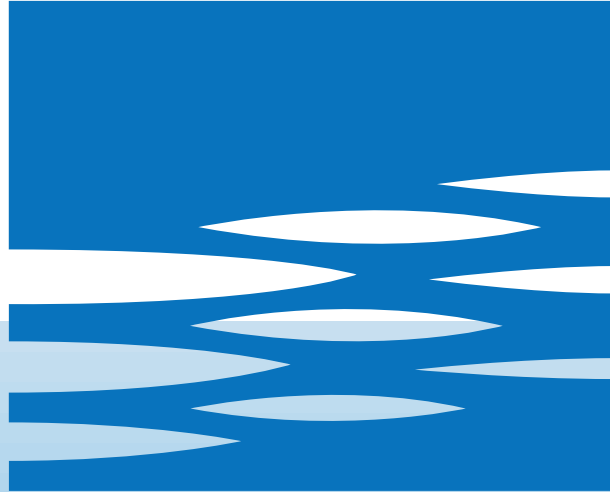

EBARA

	Page
- SPECIFICATIONS	200
SELECTION CHART	201
TYPE KEY AND CURVE SPECIFICATIONS	203
PERFORMANCE CURVE LPCD4 40	205
PERFORMANCE CURVE LPCD4 50	206
PERFORMANCE CURVE LPCD4 65	208
PERFORMANCE CURVE LPCD4 80	209
PERFORMANCE CURVE LPCD4 100	210
- CONSTRUCTIONS	300
SECTIONAL VIEW	300
MECHANICAL SEAL	301
- DIMENSIONS AND WEIGHT	400
PUMP	400
- TECHNICAL DATA	500
MOTOR DATA	500
NOISE DATA	500

SPECIFICATION

50Hz

Rev. A

PUMP		
Liquid Handled	Type of liquid	Clean water
	Temperature [°C]	min. -10 max +110
	Viscosity [°E]	max 5
Maximum ambient temperature [°C]		+40 (over ask for de tails)
Maximum working pressure [MPa]		1.0
Construction	Impeller	Closed centrifugal type
	Shaft seal type	Mechanical seal
	Bearing	On the motor
Pipe Connection	Suction	UNI 2223-29 PN16 DIN 2501
	Discharge	UNI 2223-29 PN16 DIN 2501
Material	Casing	CAST IRON
	Impeller	CAST IRON
	Casing cover	CAST IRON
	Shaft seal	Carbon/SiC/EPDM
	Shaft	AISI 420
	Bracket	CAST IRON
Applicable standard of test		ISO 9906 – Annex A

MOTOR	
Type	Electric - TEFC Three Phase
Efficiency level (Reg. 640/2009)	- from 0.25 kW up to 0.55 kW IE2 0.75 kW up to 4 kW
No. of Poles	4
Rotation speed [min ⁻¹]	≈ 1400
Insulation Class	F
Protection degree (CEI EN 60034-5)	IP 55
Power rating [kW]	0.25 ÷ 4
[HP]	0.33 ÷ 5,5
Frequency [Hz]	50
Voltage [V]	230/400 ±10%
Over load protection	Provided by the user
Casing material	Alluminum

SELECTION CHART

50Hz

Rev. A

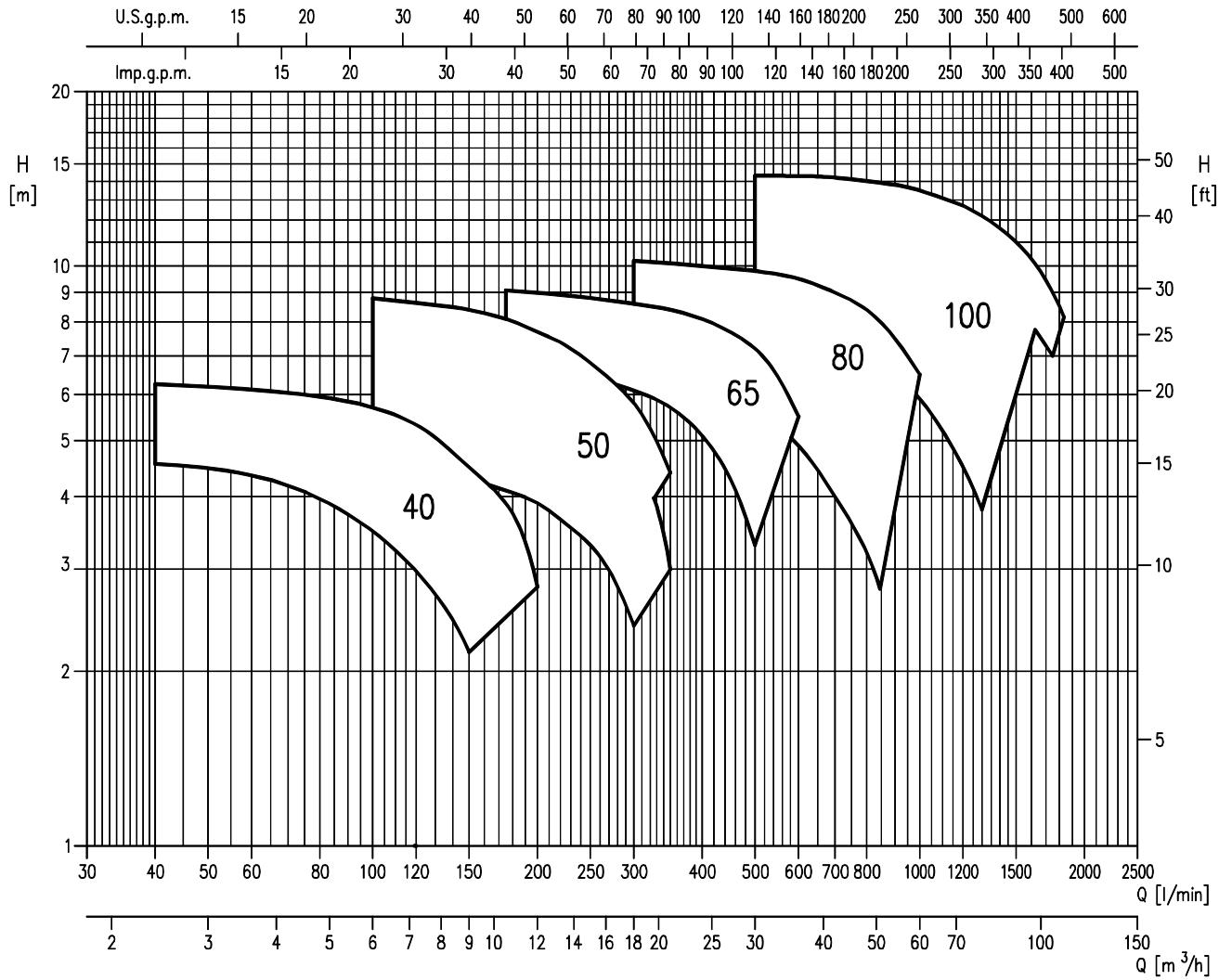

SELECTION CHART

50Hz

Rev. A

LPCD 4 Poles: 40, 50, 65 Version

Pump type LPCD4 Three Phase	Power		Capacity																	
	[kW]	[HP]	l/min	0	40	50	75	100	125	150	175	200	225	250	300	350	400	450	500	600
			m³/h	0	2,4	3	4,5	6	7,5	9	10,5	12	13,5	15	18	21	24	27	30	36
H=Total manometric head in meters																				
LPCD4 40-125/0,25R	0,25	0,33	4,8	4,5	4,4	4,1	3,7	3	2,2	-	-	-	-	-	-	-	-	-	-	-
LPCD4 40-125/0,25	0,25	0,33	6,3	-	6,2	6	5,7	5,2	4,5	3,9	2,8	-	-	-	-	-	-	-	-	-
LPCD4 50-125/0,25	0,25	0,33	4,8	-	-	-	4,6	4,5	4,3	4,1	3,9	3,6	3,3	2,4	-	-	-	-	-	-
LPCD4 50-125/0,37	0,37	0,5	6,4	-	-	-	6,3	6,2	6,1	6	5,8	5,6	5,3	4,6	3	-	-	-	-	-
LPCD4 50-160/0,55	0,5	0,7	9,2	-	-	-	8,8	8,6	8,4	8,1	7,7	7,3	6,8	5,8	4,4	-	-	-	-	-
LPCD4 65-160/0,75R	0,55	0,75	6,9	-	-	-	-	-	6,8	6,7	6,6	6,5	6,4	6,1	5,7	5,1	4,3	3,3	-	-
LPCD4 65-160/0,75	0,75	1	8,3	-	-	-	-	-	-	-	8,1	8	7,9	7,8	7,4	7	6,6	6	4	-
LPCD4 65-160/1.1	0,9	1,25	9,1	-	-	-	-	-	-	-	-	9,0	8,9	8,8	8,7	8,4	8,1	7,7	7,2	5,5

LPCD 4 Poles: 80, 100 Version

Pump type LPCD4 Three Phase	Power		Capacity																	
	[kW]	[HP]	l/min	0	300	350	400	450	500	600	700	800	900	1000	1100	1200	1300	1500	1750	2000
			m³/h	0	18	21	24	27	30	36	42	48	54	60	66	72	78	90	105	120
H=Total manometric head in meters																				
LPCD4 80-160/0,75	0,75	1	6,4	6,3	6,1	6	5,8	5,6	4,9	4	3,2	-	-	-	-	-	-	-	-	-
LPCD4 80-160/1.1R	0,90	1,25	7,4	7,3	7,2	7,1	7	6,8	6,3	5,6	4,8	3,8	-	-	-	-	-	-	-	-
LPCD4 80-160/1,1	1,1	1,5	8,6	8,5	8,5	8,4	8,3	8,2	7,9	7,3	6,7	5,9	5	-	-	-	-	-	-	-
LPCD4 80-160/1,5	1,5	2	10,3	10,2	10,1	10	9,9	9,8	9,5	9	8,4	7,5	6,5	-	-	-	-	-	-	-
LPCD4 100-200/1,5	1,5	2	8,6	-	-	-	-	8,1	7,8	7,4	7	6,5	5,9	5,2	4,5	3,8	-	-	-	-
LPCD4 100-200/2,2	2,2	3	10,6	-	-	-	-	10,2	10	9,7	9,3	9	8,6	8,2	7,7	7,2	6	-	-	-
LPCD4 100-200/3	3	4	12,7	-	-	-	-	-	12	11,8	11,5	11,3	10,9	10,5	10	9,5	8,5	7	-	-
LPCD4 100-200/4	4	5,5	14,9	-	-	-	-	-	14,3	14,2	14	13,8	13,4	13,1	12,7	12,2	11	9	6,5	-

TYPE KEY AND CURVE SPECIFICATION

50Hz

Rev. A

TYPE KEY:

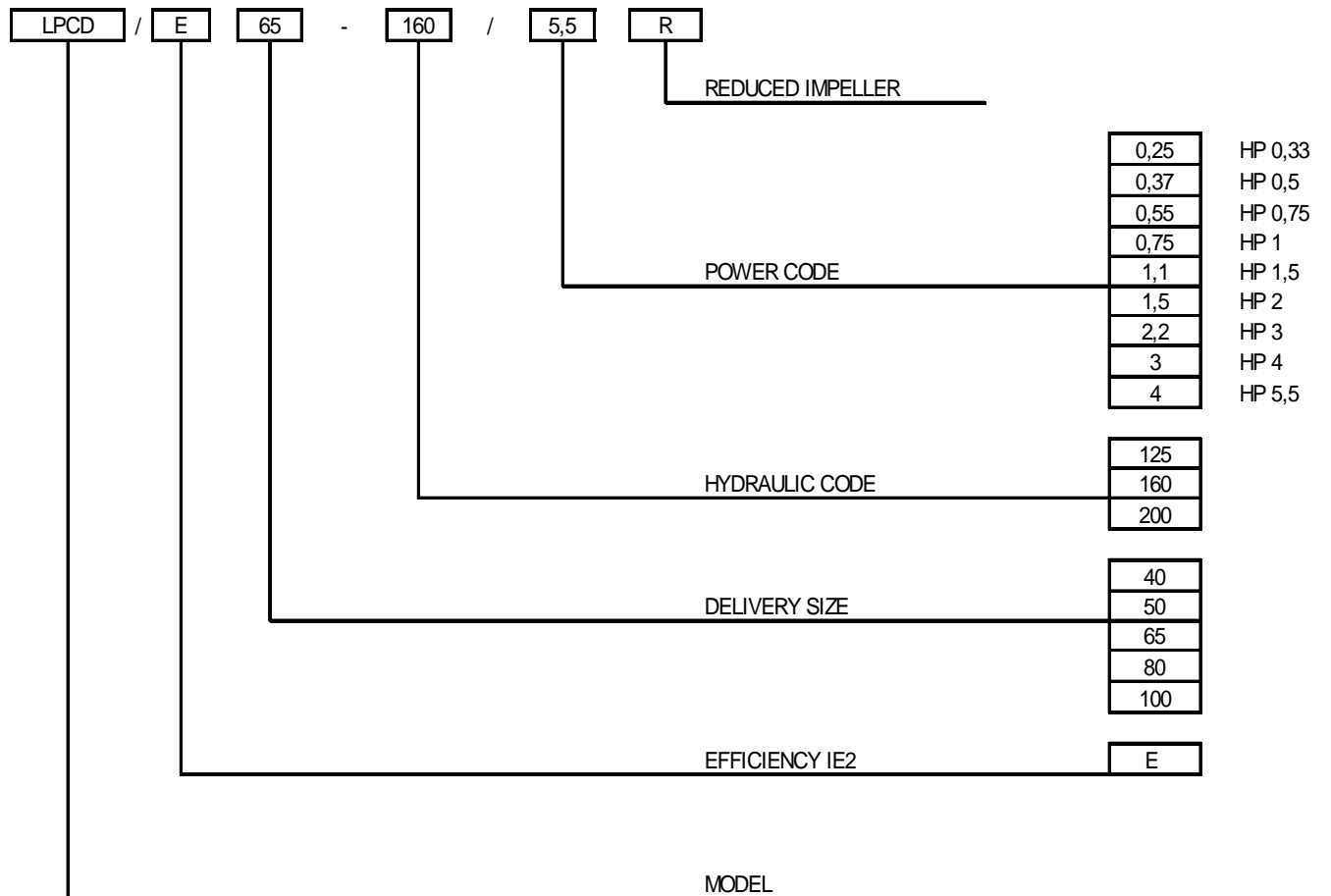

PERFORMANCE CURVE SPECIFICATIONS

The specifications below qualify the curves shown on the following pages.

Tolerances according to ISO 9906 Annex A

The curves refer to effective speed of asynchronous motors at 50 Hz

Measurements were carried out with clean water at 20°C of temperature and with a kinematic viscosity of $\nu = 1 \text{ mm}^2/\text{s}$ (1 cSt)

The NPSH curve is an average curve obtained in the same conditions of performance curves.

The continuous curves indicate the recommended working range. The dotted curve is only a guide.

In order to avoid the risk of over-heating, the pumps should not be used at a flow rate below 10% of best efficiency point.

Symbols explanation:

- Q = volume flow rate
- H = total head
- P_2 = pump power input (shaft power)
- η = pump efficiency
- NPSH = net positive suction head required by the pump
- MEI = minimum efficiency index

The minimum efficiency index (MEI) is a measure of the quality of a pump size in respect to its mean efficiency. The minimum efficiency index is based on the hydraulic efficiency and on the head at the best efficiency point.

The efficiency of a pump with trimmed impeller is usually lower than that of a pump with the full impeller diameter. The trimming of the impeller will adapt the pump to a fixed duty point, leading to reduced energy consumption. The minimum efficiency index (MEI) is based on the full impeller diameter.

The operation of these water pumps with variable duty points may be more efficient and economic when controlled, for example, by the use of a variable speed drive that matches the pump duty to the system.

MEI = 0.4 for ESCCi 2900rpm

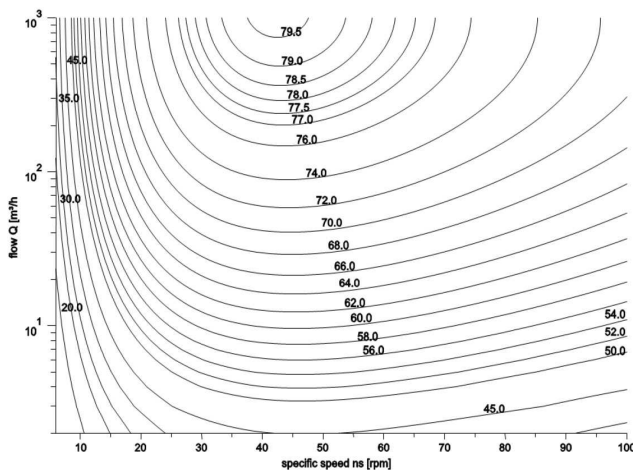

MEI=0.7 for ESCCi 2900 rpm

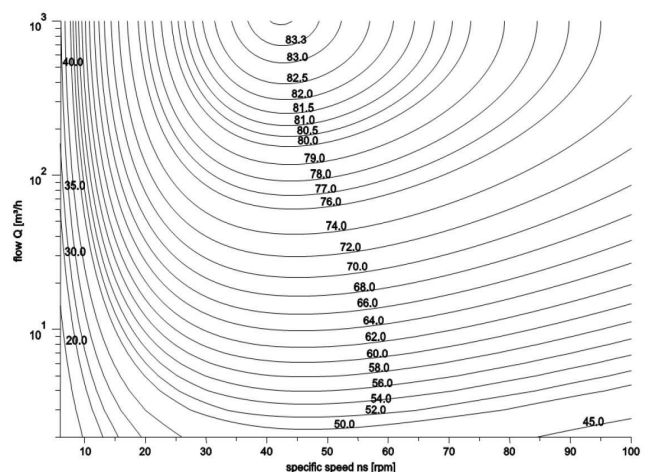

PERFORMANCE CURVE

50Hz

Rev. A

LPCD 40-125/0.25R (0.25 kW)
LPCD 40-125/0.25 (0.25 kW)

MEI > 0.40 Impeller diameter = 120 mm
MEI > 0.40 Impeller diameter = 139 mm

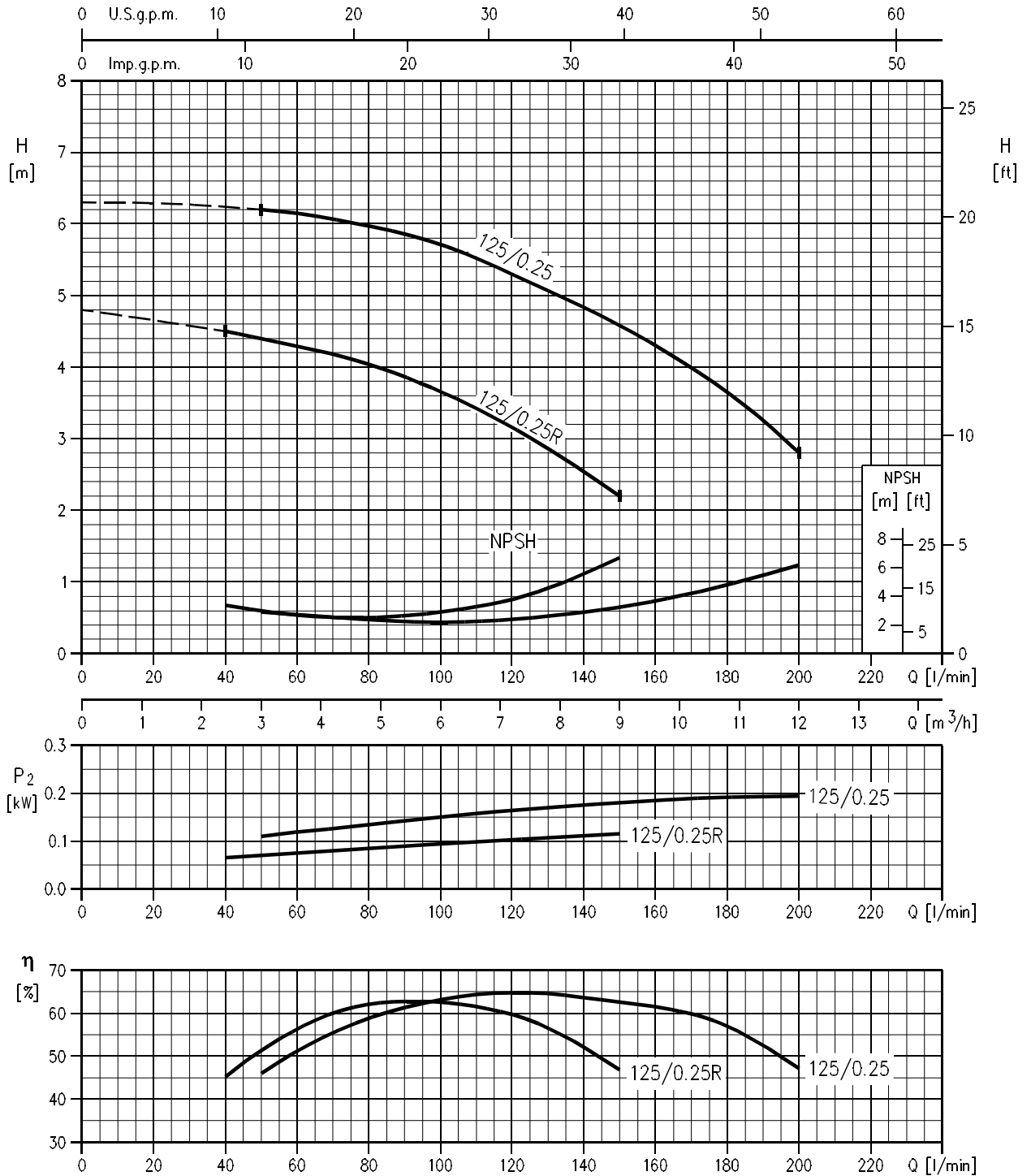

Rotation speed $\approx 1400 \text{ min}^{-1}$
Test standard: ISO 9906 – Annex A

PERFORMANCE CURVE

50Hz

Rev. A

LPCD4 50-125/0.25 (0.25 kW) MEI > 0.40 Impeller diameter = 129 mm
 LPCD4 50-125/0.37 (0.37 kW) MEI > 0.40 Impeller diameter = 140.5 mm

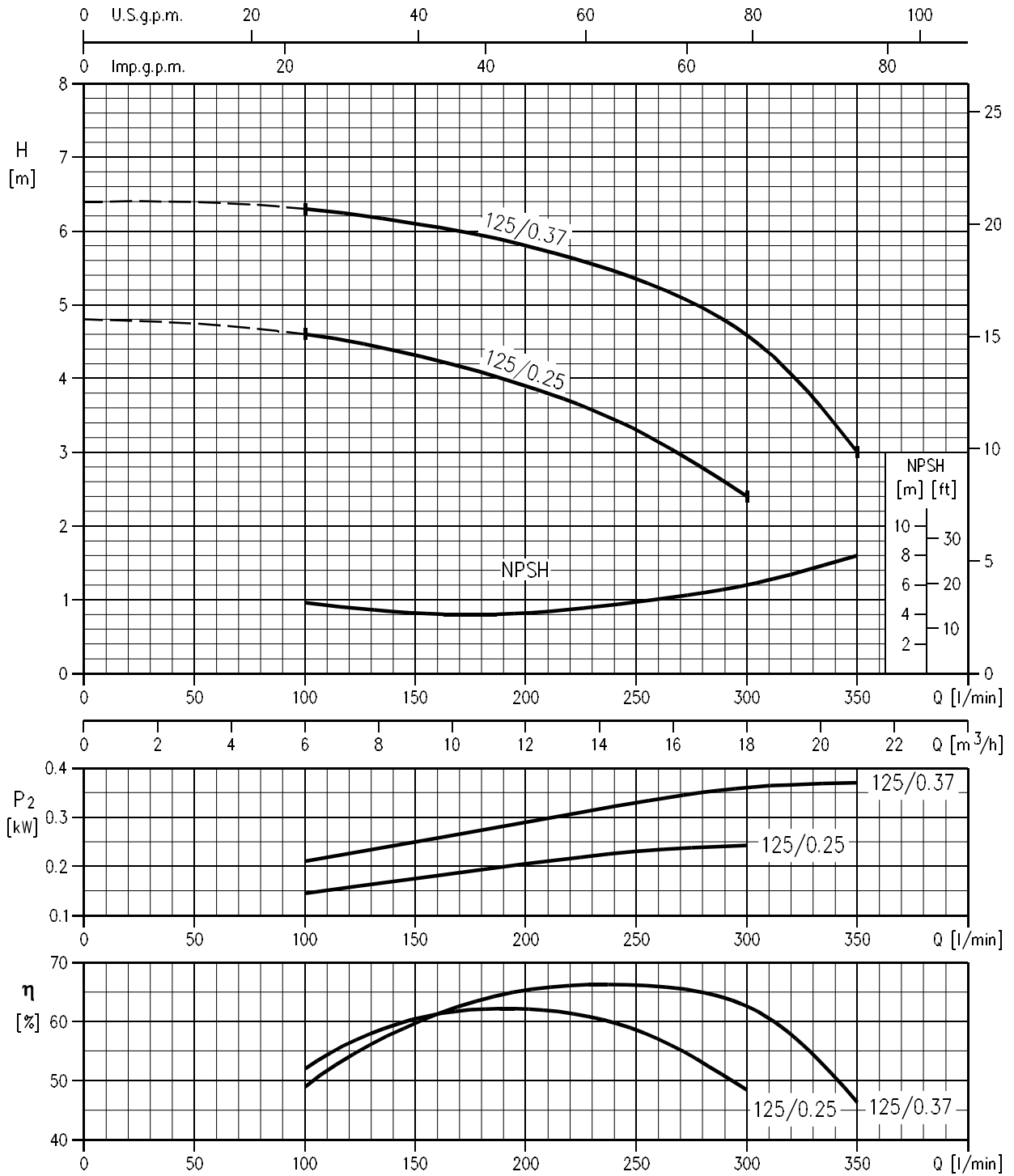

Rotation speed ≈ 1400 min⁻¹
 Test standard: ISO 9906 – Annex A

LPCD4 50-160/0.55 (0.55 kW) MEI > 0.40 Impeller diameter = 169 mm

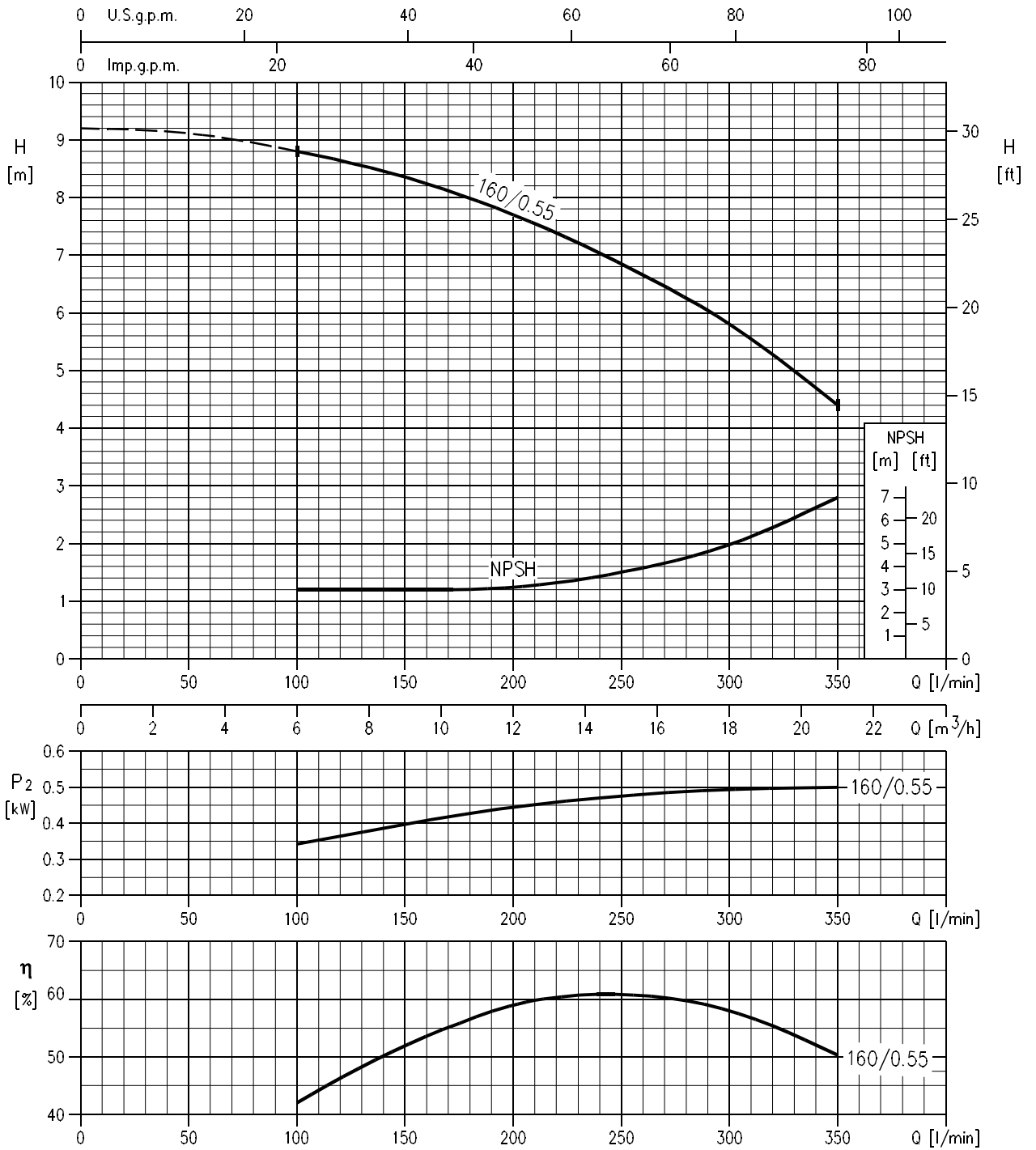

Rotation speed $\approx 1400 \text{ min}^{-1}$
 Test standard: ISO 9906 – Annex A

PERFORMANCE CURVE

50Hz

Rev. A

LPCD4 65-160/0.75R (0.75 kW) MEI > 0.40 Impeller diameter = 150 mm
 LPCD4 65-160/0.75 (0.75 kW) MEI > 0.40 Impeller diameter = 160 mm
 LPCD4 65-160/1.1 (1.1 kW) MEI > 0.40 Impeller diameter = 169 mm

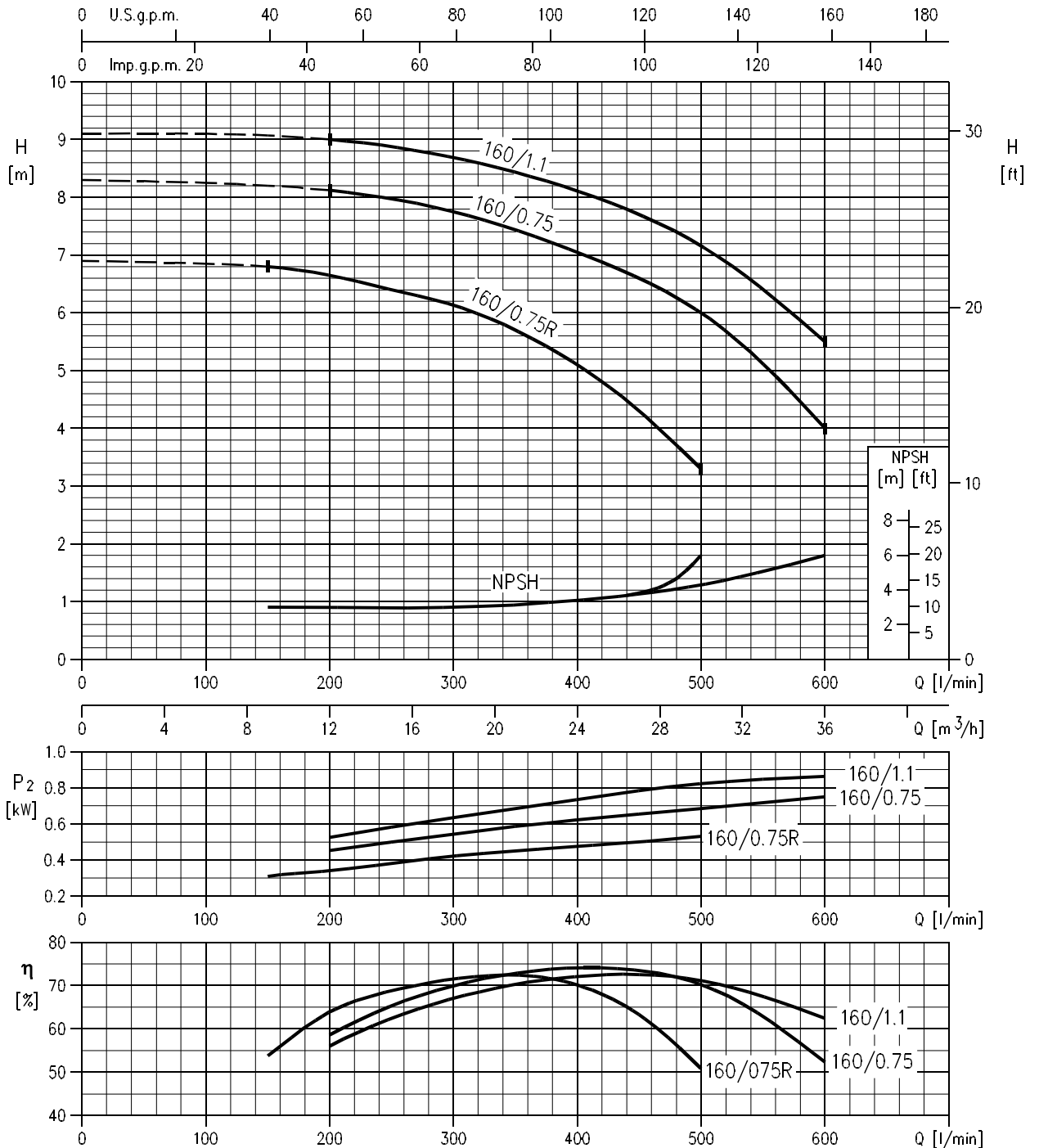

Rotation speed $\approx 1400 \text{ min}^{-1}$
 Test standard: ISO 9906 – Annex A

PERFORMANCE CURVE

50Hz

Rev. A

LPCD4 80-160/0.75 (0.75 kW) MEI > 0.40 Impeller diameter = 138 mm
 LPCD4 80-160/1.1R (1.1 kW) MEI > 0.40 Impeller diameter = 148 mm
 LPCD4 80-160/1.1 (1.1 kW) MEI > 0.70 Impeller diameter = 158 mm
 LPCD4 80-160/1.5 (1.5 kW) MEI > 0.70 Impeller diameter = 169 mm

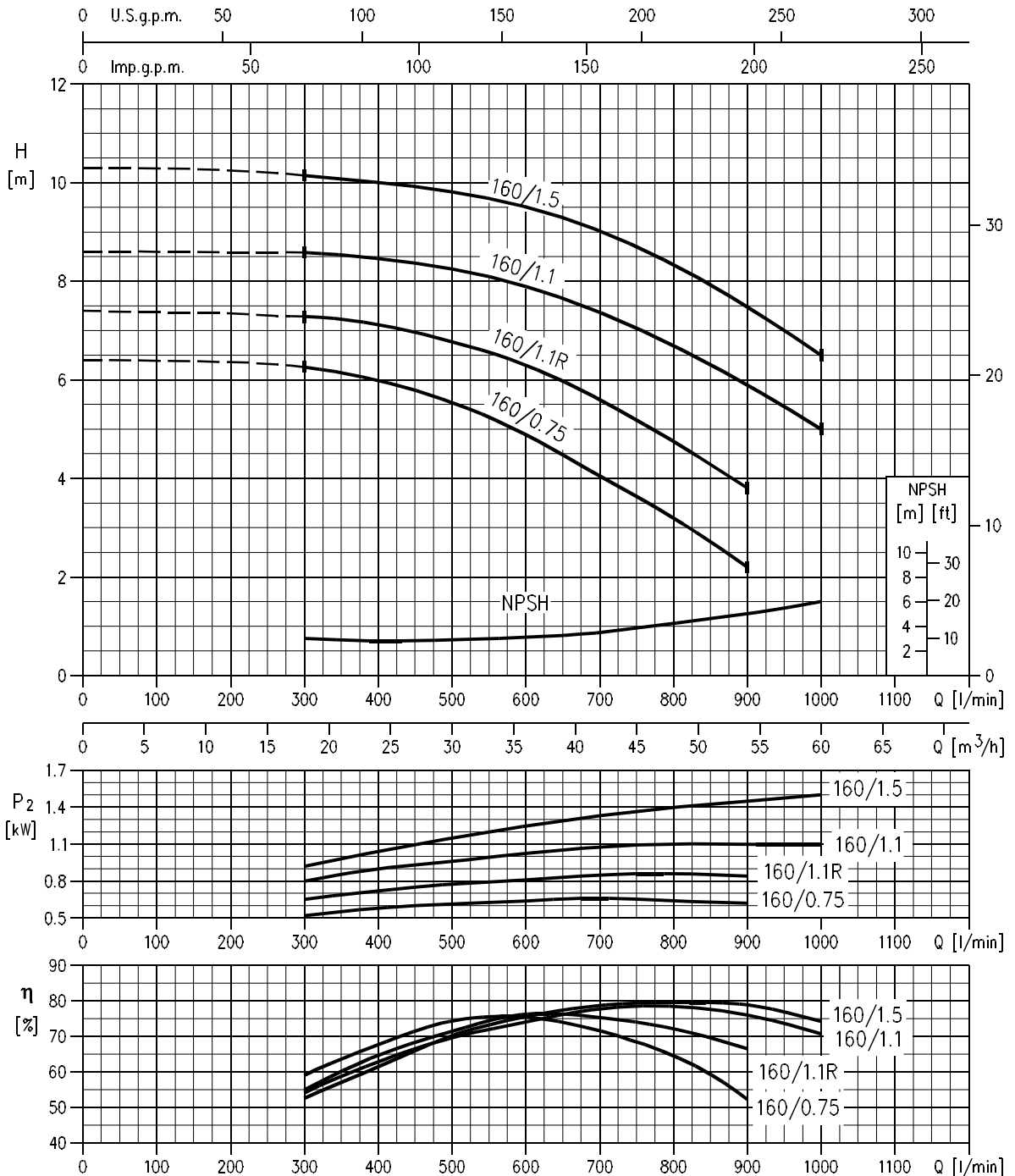

Rotation speed ≈ 1400 min
 Test standard: ISO 9906 – Annex A

PERFORMANCE CURVE

50Hz

Rev. A

LPCD4 100-200/1.5 (1.5 kW) MEI > 0.40 Impeller diameter = 165 mm
LPCD4 100-200/2.2 (2.2 kW) MEI > 0.40 Impeller diameter = 185 mm
LPCD4 100-200/3.0 (3.0 kW) MEI > 0.40 Impeller diameter = 200 mm
LPCD4 100-200/4.0 (4.0 kW) MEI > 0.40 Impeller diameter = 209 mm

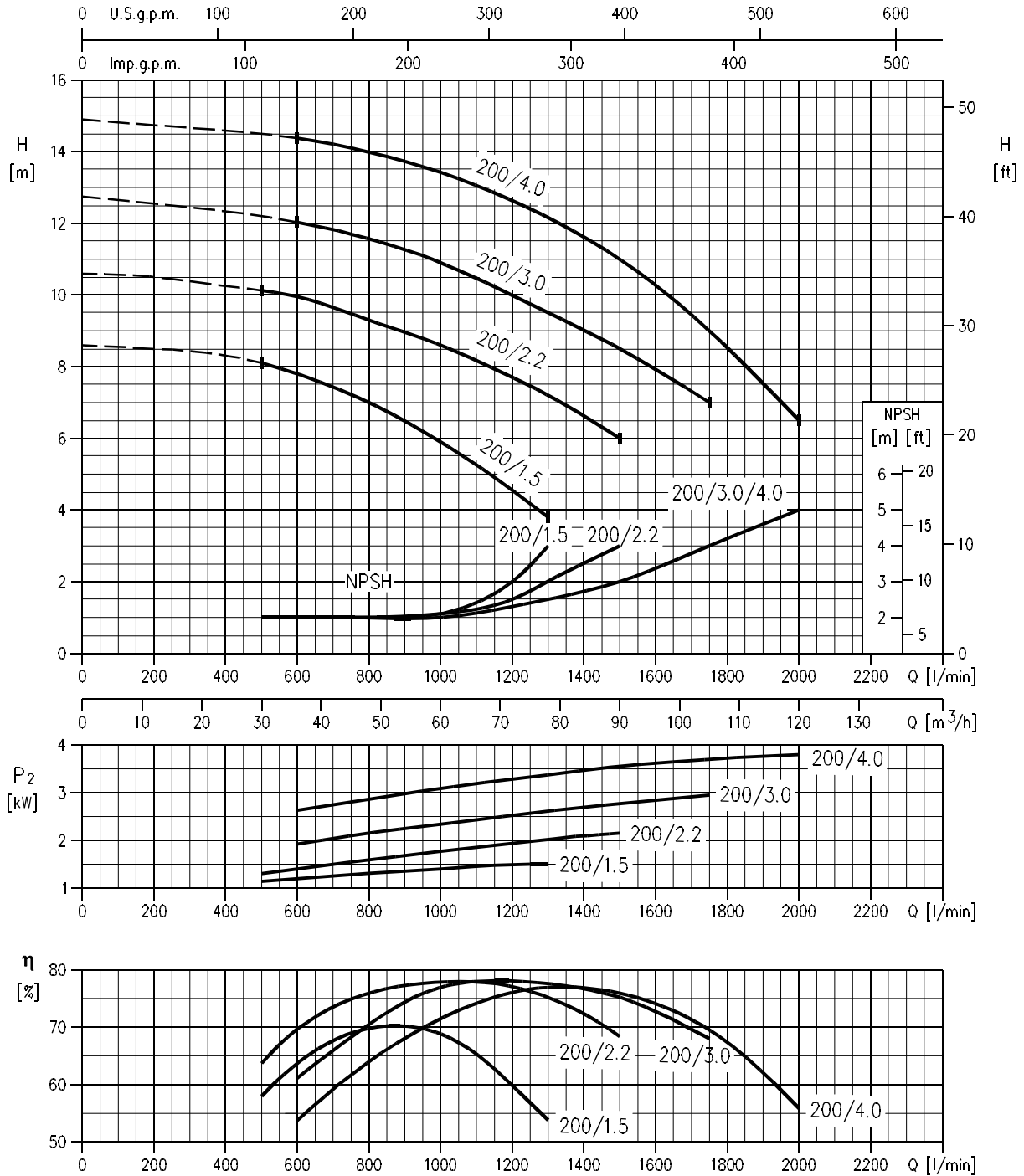

Rotation speed ≈ 1400 min⁻¹
 Test standard: ISO 9906 – Annex A

SECTIONAL VIEW DRAWING

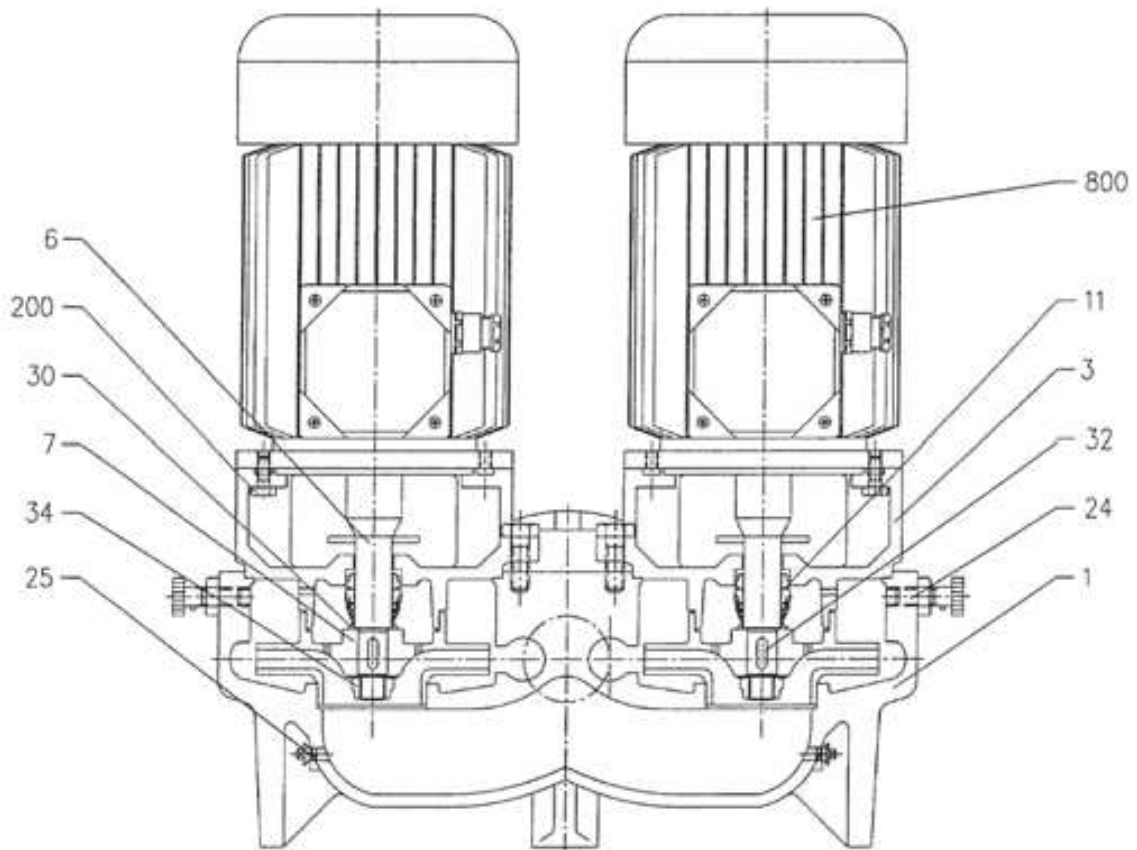

N°	PART NAME	MATERIAL
1	Casing	Cast Iron
3	Motor bracket	Cast Iron
6	Shaft with rotor	AISI 420
7	Impeller	Cast Iron
11	Mechanical seal	Carbon/SiC/EPDM
24	Priming plug	Stainless steel
25	Drain plug	Stainless steel
30	Spacer	Stainless steel
32	Key	Stainless steel
34	Impeller nut	Stainless steel
200	Screw	Stainless steel
800	Motor frame with stator	Aluminum

MECHANICAL SEAL

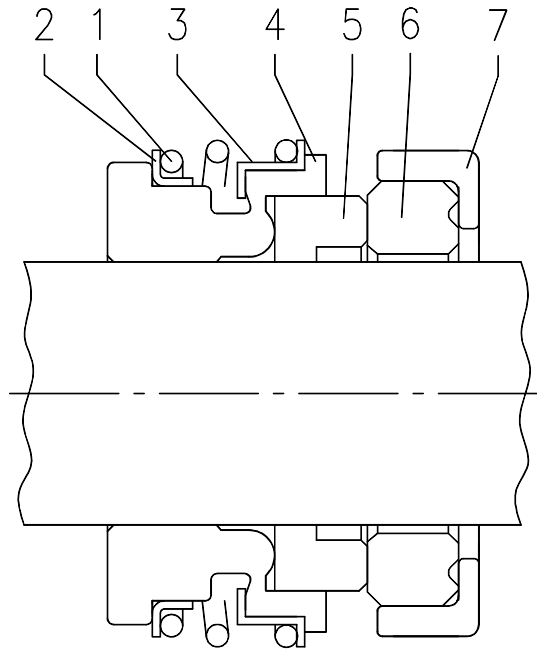

REF	PART NAME	MATERIAL (Max temperature: 110°C)
1	Spring	AISI 316
2	O Ring	EPDM
3	Frame	AISI 316
4	O Ring	EPDM
5	Rotating part	Carbon
6	Fixed part	SiC
7	Rubber cover	EPDM

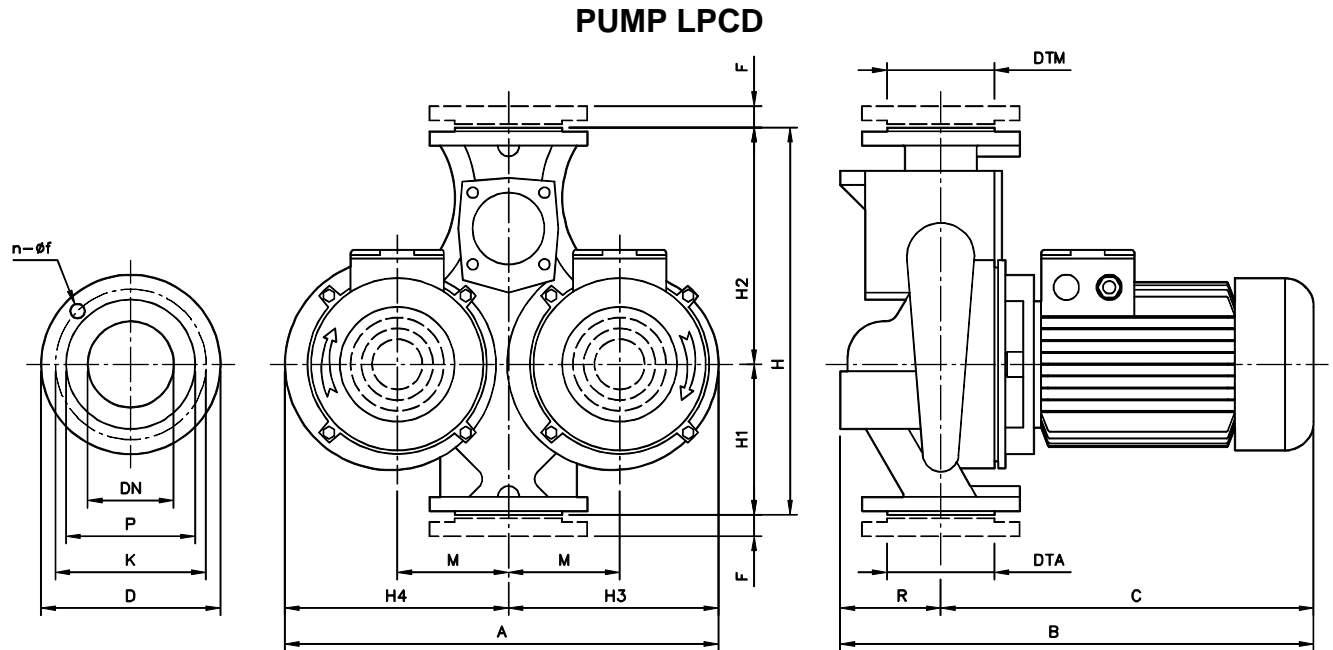

Model	Dimensions (mm)																		Weight (kgf)
	DTAM	DNAM	n	f	P	K	D	H	H1	H2	H3	H4	M	R	F	A	B	C	
LPCD4 40-125/0,25R	G 1 1/2	40PN16	4	18	88	110	150	340	130	210	197	200	100	100	20	397	430	330	44
LPCD4 40-125/0,25	G 1 1/2	40PN16	4	18	88	110	150	340	130	210	197	200	100	100	20	397	430	330	44
LPCD4 50-125/0,25	G 2	50PN16	4	18	102	125	165	365	145	220	197	200	105	110	22	397	440	330	46
LPCD4 50-125/0,37	G 2	50PN16	4	18	102	125	165	365	145	220	197	200	105	110	22	397	440	330	47
LPCD4 50-160/0,55	G 2	50PN16	4	18	102	125	165	410	170	240	235	245	120	110	22	480	440	330	53
LPCD4 65-160/0,75R	G 2 1/2	65PN16	4	18	122	145	185	450	180	270	268	275	140	130	22	543	460	330	66
LPCD4 65-160/0,75	G 2 1/2	65PN16	4	18	122	145	185	450	180	270	268	275	140	130	22	543	476	346	66
LPCD4 65-160/1,1	G 2 1/2	65PN16	4	18	122	145	185	450	180	270	268	275	140	130	22	543	511	381	79
LPCD4 80-160/0,75	G 3	80PN16	8	18	138	160	200	510	205	305	270	280	135	150	24	550	496	346	75
LPCD4 80-160/1,1R	G 3	80PN16	8	18	138	160	200	510	205	305	270	280	135	150	24	550	531	381	86
LPCD4 80-160/1,1	G 3	80PN16	8	18	138	160	200	510	205	305	270	280	135	150	24	550	531	381	86
LPCD4 80-160/1,5	G 3	80PN16	8	18	138	160	200	510	205	305	270	280	135	150	24	550	531	381	87
LPCD4 100-200/1,5	G 4	100PN16	8	18	158	180	220	630	240	390	345	325	165	180	26	670	573	393	133
LPCD4 100-200/2,2	G 4	100PN16	8	18	158	180	220	630	240	390	345	325	165	180	26	670	612	432	143
LPCD4 100-200/3	G 4	100PN16	8	18	158	180	220	630	240	390	345	325	165	180	26	670	646	466	154
LPCD4 100-200/4	G 4	100PN16	8	18	158	180	220	630	240	390	345	325	165	180	26	670	634	454	169

TECHNICAL DATA

50Hz

Rev. A

MOTOR DATA

Pump type Three Phase	Power		Efficiency	Input [kW]	Efficiency (% load) and power-factor			Full load current [A]			Locked rotor current [A]			
	[kW]	[HP]			η %			cos ϕ	230 V	400 V	690 V	230 V	400 V	690 V
					50%	75%	100%							
LPCD4 40-125/0,25R	0,25	0,33	-	0,41	-	-	-	-	1,6	0,9	-	5,0	2,9	-
LPCD4 40-125/0,25	0,25	0,33	-	0,41	-	-	-	-	1,6	0,9	-	5,0	2,9	-
LPCD4 50-125/0,25	0,25	0,33	-	0,41	-	-	-	-	1,6	0,9	-	5,0	2,9	-
LPCD4 50-125/0,37	0,37	0,5	-	0,56	-	-	-	-	2,1	1,2	-	6,9	4,0	-
LPCD4 50-160/0,55	0,55	0,75	-	0,56	-	-	-	-	2,1	1,2	-	6,9	4,0	-
LPCD4 65-160/0,75R	0,75	1,0	IE2	0,93	75,0	78,1	79,4	0,71	3,3	1,9	-	17,1	9,8	-
LPCD4 65-160/0,75	0,75	1,0	IE2	0,93	75,0	78,1	79,4	0,71	3,3	1,9	-	17,1	9,8	-
LPCD4 65-160/1.1	1,1	1,5	IE2	1,33	81,4	82,7	82,5	0,77	4,3	2,5	-	26,4	15,3	-
LPCD4 80-160/0,75	0,75	1,0	IE2	0,93	75,0	78,1	79,4	0,71	3,3	1,9	-	17,1	9,8	-
LPCD4 80-160/1.1R	1,1	1,5	IE2	1,33	81,4	82,7	82,5	0,77	4,3	2,5	-	26,4	15,3	-
LPCD4 80-160/1,1	1,1	1,5	IE2	1,33	81,4	82,7	82,5	0,77	4,3	2,5	-	26,4	15,3	-
LPCD4 80-160/1,5	1,5	2	IE2	1,81	81,0	83,5	83,0	0,77	5,9	3,4	-	46,5	26,8	-
LPCD4 100-200/1,5	1,5	2	IE2	1,81	81,0	83,5	83,0	0,77	5,9	3,4	-	46,5	26,8	-
LPCD4 100-200/2,2	2,2	3	IE2	2,61	84,0	85,3	85,1	0,74	8,9	5,1	-	53,0	30,6	-
LPCD4 100-200/3	3	4	IE2	3,47	82,6	84,7	86,4	0,77	11,3	6,5	-	95,7	55,3	-
LPCD4 100-200/4	4	5,5	IE2	4,59	86,0	87,3	87,1	0,78	14,8	8,5	-	89,7	51,8	-

NOISE DATA

Pump type Three Phase	Power		LpA - dB(A) *
	[kW]	[HP]	
LPCD4 40-125/0,25R	0,25	0,33	<70
LPCD4 40-125/0,25	0,25	0,33	
LPCD4 50-125/0,25	0,25	0,33	
LPCD4 50-125/0,37	0,37	0,5	
LPCD4 50-160/0,55	0,55	0,75	
LPCD4 65-160/0,75R	0,75	1	
LPCD4 65-160/0,75	0,75	1	
LPCD4 65-160/1.1	1,1	1,5	
LPCD4 80-160/0,75	0,75	1	
LPCD4 80-160/1.1R	1,1	1,5	
LPCD4 80-160/1,1	1,1	1,5	
LPCD4 80-160/1,5	1,5	2	
LPCD4 100-200/1,5	1,5	2	
LPCD4 100-200/2,2	2,2	3	
LPCD4 100-200/3	3	4	
LPCD4 100-200/4	4	5,5	78

* Mean value of several measures at 1m distance around the pump. Tolerance ± 2.5 dB.