



Japanese Technology since 1912

2CDX Booster Sets

Data Book 50Hz

INDEX

Page

INDEX	
DEFINITION AND USE OF PRESSURISATION UNITS	101
TYPICAL APPLICATIONS	101
PRINCIPLE OF OPERATION OF GP PRESSURISATION UNITS	101
PRINCIPLE OF OPERATION OF GPE PRESSURISATION UNITS	101
OPERATING CONDITIONS	102
TESTS AND TRIALS	102
MECHANICAL AND HYDRAULIC TESTS	102
ELECTRICAL TESTS	102
Principle of Operation of GPE Pressurisation UNITS with E-drive	102
Principle of Operation of GPE Pressurisation UNITS with E-power and Hydrocontroller	102
Principle of Operation of GPE Pressurisation UNITS with an EFC control panel	103
Principle of Operation of GPE Pressurisation UNITS with an MFC control panel	103
Fig. 1 - TWO PUMP UNIT WITH CONSTANT PRESSURE REGULATION	104
PRESSURISATION UNIT WATER CIRCUIT DIAGRAM	104
TYPE KEY	105
NAME PLATE	105
PRODUCT SPECIFICATIONS	201
HYDRAULIC COMPONENTS AND CONTROL	201
ELECTRIC PANEL	202
TECHNICAL PUMP DATA	202
TECHNICAL MOTOR DATA	203
PERFORMANCE RANGE	301
RESEAU BOOSTER SET 2GP 2CDX(.)	301
CURVE SPECIFICATION 2GP	401
SELECTION CHART 2GP 2CDX(.)	402
PERFORMANCE CURVE 2GP	403
2GP 2CDX 70/10(M)	403
2GP 2CDX 70/12(M)	404
2GP 2CDX 70/15(M)	405
2GP 2CDX 70/20(M)	406
2GP 2CDX 120/15(M)	407
2GP 2CDX 120/20(M)	408
2GP 2CDX 120/30	409
2GP 2CDX 120/40	410
2GP 2CDX 200/30	411

2GP 2CDX 200/40	412
2GP 2CDX 200/50	413
2GP CONSTRUCTION	601
EXTERNAL VIEW 2GP 2CDX(.) 70-120	601
EXTERNAL VIEW 2GP 2CDX(.) 200	602
OVERALL DIMENSIONS 2GP BOOSTER SET	701
2GP 2CDX(.)	701
PACKING	702
CONTROL PANEL FIXED SPEED	801
2EP SPECIFICATION	801

① click INDEX to jump CORRESPONDING SECTION

INTENTIONALLY EMPTY PAGE

DEFINITION AND USE OF PRESSURISATION UNITS

In situations in which a municipal water mains is lacking or insufficient for the proper operation of the services, one must install a pressurization unit to provide acceptable pressure and flow rates to even in the most unfavourable services. Pressurisation units are used wherever there is a need to increase the pressure, or to pressurise a water circuit. **EBARA GP pressurisation units** are automatic systems with 2 or more pumps operating in parallel, designed to provide a simple and reliable solution to the most common requirements for maintenance of water supply pressure for apartment buildings, hotels, centres, offices and schools as well as providing auxiliary service in industrial and agricultural applications. They stand out for their robust construction, compact size, excellent efficiency and silent operation. GP units are equipped for connection to membrane and air cushion autoclaves. They are controlled by pressure switches or, for units with INVERTER control, by the signal from a pressure transducer.

TYPICAL APPLICATIONS

INDUSTRY	BUILDING SERVICE	WATER SUPPLY
		

PRINCIPLE OF OPERATION OF GP PRESSURISATION UNITS

When water is demanded, it is first drawn from the autoclave tank (if present). This demand for water, with the pumps stopped, lowers the pressure until the pressure switch with the highest setpoint trips and starts the first electropump. If the output flow is greater than the delivery capacity of a single pump, the pressure continues falling until it trips the second pressure switch, thus starting the second pump. This happens for all pumps in the unit. When the water demand stops or reduces, the system pressure rises, thus opening the pressure switches sequentially and shutting off the pumps one by one. This is done in inverse order to that in which the motors were started up, the number of hourly starts per pump is reduced and they are all used to the same extent.

NB: By connecting a float switch or minimum pressure switch to the control panel (both for demand from the first accumulation tank and from the water circuit itself) one can prevent the most frequent cause of pump failure: dry running.

PRINCIPLE OF OPERATION OF GPE PRESSURISATION UNITS

GPE units are designed to operate with a pump controlled by an **INVERTER** in the control panel, on board the motor, or in-line. The unit thus maintains constant pressure in the water circuit.

There are various versions of GPE unit:

- With **INVERTER** in the control panel (Standard **EFC** version)
With a single **INVERTER** controlling a single pump which is alternated with the others at each start up (MFC version, on request, in which each pump is **INVERTER** controlled).
- With multiple **INVERTERS**, each pump controlled by its own **INVERTER** (**MFC versions**, versions with **INVERTER** on board motor or in-line **INVERTER**)

Note: Not all control options shown in the introduction are available with 2CDX pumps

OPERATING CONDITIONS

EBARA GP-GPE pressurisation units can be used, in their standard versions, for civil, industrial and agricultural applications, as follows:

- building service
- water lifting and handling
- A/C
- heating
- irrigation
- washing systems

The conveyed fluid must be: clean, potable, ground or mixed water, free of solid or fibrous suspensions and aggressive chemical substances.

The units must be installed under cover, protected from the weather and freezing.

- Conveyed water temperature 0 - 50°C (depending on pumps).
- Ambient operating temperature 0 - 40°C, no higher than 1000 m above sea level.
- Max relative humidity 50% at +40°C.

NB: The system available NPSH must be greater than the NPSH demanded from the pump. For applications with different technical specifications, uses and climatic conditions (type of vector fluid, marine and aggressive industrial conditions), please contact our sales network.

TESTS AND TRIALS

Before shipping, all EBARA pressurisation units are subject to hydraulic, mechanical and electrical testing.

MECHANICAL AND HYDRAULIC TESTS

- Pressure switch calibration
- Pump direction of rotation
- Mechanical testing of moving parts and running noise (on each pump)
- Tightness test with delivery port closed and nameplate rating tests
- MANUAL trials (using button on control panel) for each pump
- AUTOMATIC trials (using switch on control panel) for unit

ELECTRICAL TESTS

- Earthing system continuity
- Applied voltage (dielectric rigidity)
- Insulation resistance

Principle of Operation of GPE Pressurisation UNITS with E-drive

GPE units with E-drive are designed to operate with each pumps controlled by an INVERTER installed on board its motor. The system is controlled by an MASTER INVERTER in relation to the reference signal supply by a pressure transmitters (4 - 20 mA passive). As the system pressure varies, the MASTER pump varies its rotary speed to restore it to the setpoint. If the water demand exceeds the capacity of the pump, the second variable speed pump cuts in and, pump goes into regulation mode to maintain the pressure setpoint; this happens for all the pumps in the unit. If the water demand drops off, the pressure tends to increase and the latest pump gradually reduces its speed to restore the correct operating pressure. This results in the regulation of the speed of the other pumps, until they gradually turn off. Once the system pressure has been restored and the water demand is 0, the MASTER pump switches off automatically.

Principle of Operation of GPE Pressurisation UNITS with E-power and Hydrocontroller

GPE units with E-power and Hydrocontroller are two pumps unit and are designed to operate with pumps controlled by an INVERTER in-line type. As the system pressure varies, the MASTER pump varies its rotary speed to restore it to the setpoint. If the water demand exceeds the capacity of the pump, the second variable speed pump cuts in and, the two pumps rotate at variable synchronous speed to restore the operating pressure. If the water demand drops off, the pressure tends to increase and both pumps gradually reduces its speed to restore the correct operating pressure. This results in the regulation of the speed of the other pumps, until they gradually turn off when the water demand is 0.

Principle of Operation of GPE Pressurisation UNITS with an EFC control panel

EFC multiple pump control units power pump n. 1 with the INVERTER to modulate system performance in relation to the reference signal while the other pumps are run at maximum nominal speed (around 2900 rpm) and started and stopped in relation to demand. These means there are two distinct primary electrical circuits:

- n. 1 - INVERTER startup/control of a single pump,
- n. 2 - contactor startup (direct or star/delta) of the other pumps.

The system is controlled by an electronic controller in relation to the reference signal supply by a pressure transmitter, flow meter or other unified control signal (4 - 20 mA passive).

If the electronic controller or pressure transducer fails, a system of pressure switches controls the pumps directly (if present).

- In case of water distribution at constant pressure (Fig.1), the electronic controller is connected to the pressure transmitter on the units' delivery manifold, which outputs a signal proportional to the circuit pressure. When the pressure drops due to water demand, the pressure transmitter signal also drops and the controller starts and controls the speed of the first pump with the INVERTER to restore the reference/ operating pressure. If the pump's flow rate is lower than demand, the circuit pressure will continue to drop and the system responds by increasing the pump's speed. Once pump n. 1 reaches its maximum speed and demand is still in excess of its delivery, the controller will start pump n. 2 at maximum speed. The speed of pump n. 1 is immediately modulated so as to establish the operating pressure. If the pressure drops even further and pump n. 1 is once again running at maximum speed, the controller starts up pump n. 3, and so on for all pumps in the unit. If the water demand drops off, the pressure tends to increase and the controller reduces the speed of pump n. 1 to restore the correct operating pressure. At this point, the controller will stop one of the pumps running at maximum speed, while the speed of pump n. 1 is modulated to maintain the reference pressure. As the pressure continues to increase due to reduced demand, once the minimum speed of pump n. 1 is reached once more the controller will stop pump n. 3 and then pump n. 2. Once the demand for water has completely ceased, the controller reduces the speed of pump n. 1 to its minimum and after a set delay (around 1 minute) stops this pump too. The next time the system is started up, the INVERTER controlled pump will no longer be pump n. 1, but n. 2. The INVERTER controlled pump thus rotates through all pumps in sequence.

Principle of Operation of GPE Pressurisation UNITS with an MFC control panel

MFC multiple pump control panels power each pump with an INVERTER to modulate system performance in relation to the reference signal. MFC controllers differ from EFC controller from the point of view of their construction, since instead of having a single INVERTER to control all the pumps, each pump has its own INVERTER. The two types of control panel differ in construction, but they have the same type of operation by the controller, which responds to the reference signal output by a pressure transmitter or other unified control (4 - 20 mA passive). If the electronic controller or pressure transducer fails, a system of pressure switches controls the INVERTERS directly.

- In case of water distribution at constant starting pressure (Fig.1), the electronic controller is connected to the pressure transmitter on the units' delivery manifold, which outputs a signal proportional to the circuit pressure. When the pressure drops due to water demand, the pressure transmitter signal also drops and the controller starts and controls the speed of the first pump with the INVERTER to restore the reference/ operating pressure. If the pump's flow rate is lower than demand, the circuit pressure will continue to drop and the system responds by increasing the pump's speed. Once pump n. 1 reaches its maximum speed and demand is still in excess of its delivery, the controller will start pump n. 2, also at variable synchronous speed. The controller will modulate the speed of the two pumps to restore the operating pressure; the modulating frequency is the same for both pumps. If the pressure drops even further and pumps n. 1 and 2 are once again running at maximum speed, the controller starts up pump n. 3, and then pump n. 4, if present. When the water demand is reduced the pressure will end to increase, as does the pressure transmitter output value. The controller thus reduces the speed of pumps n. 1, 2, 3 and 4 (they are all controlled at the same speed) to restore the reference/ operating pressure. If the pumps' flow rate is greater than demand, the circuit pressure will continue to increase and the system responds by decreasing the speed of the pumps until it reaches the minimum speed setting. At this point, the controller will stop pump n. 4, while the speed of pumps n. 1, 2 and 3 is modulated to maintain the reference pressure. As the pressure continues to increase due to reduced demand, once the minimum speed setting is reached again, the controller will stop pump n. 3 and modulate the speed of pumps n. 1 and 2. This continues in sequence as the demand continues to fall, until the unit is completely stopped.

Fig. 1 - TWO PUMP UNIT WITH CONSTANT PRESSURE REGULATION

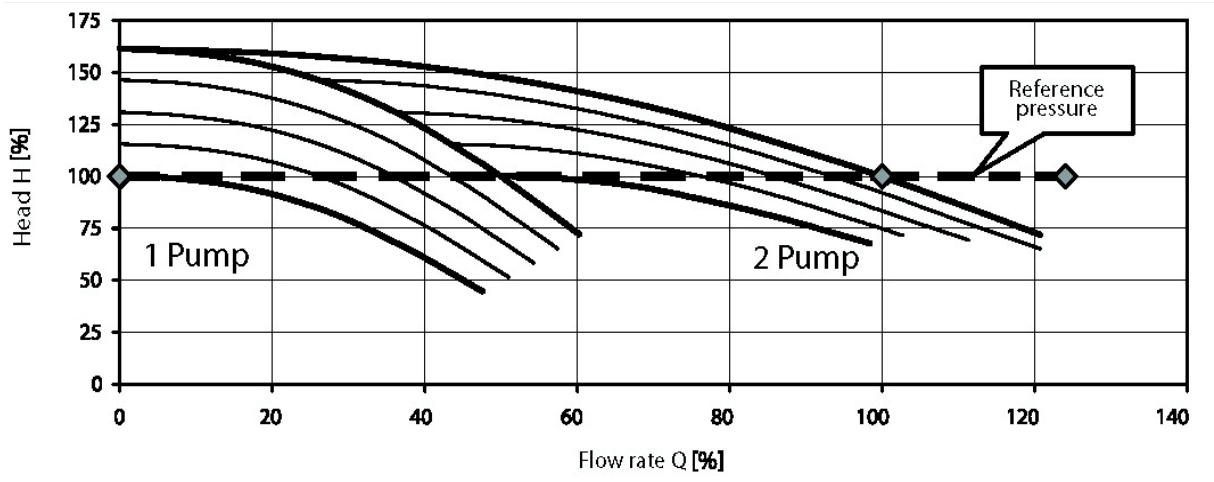

PRESSURISATION UNIT WATER CIRCUIT DIAGRAM

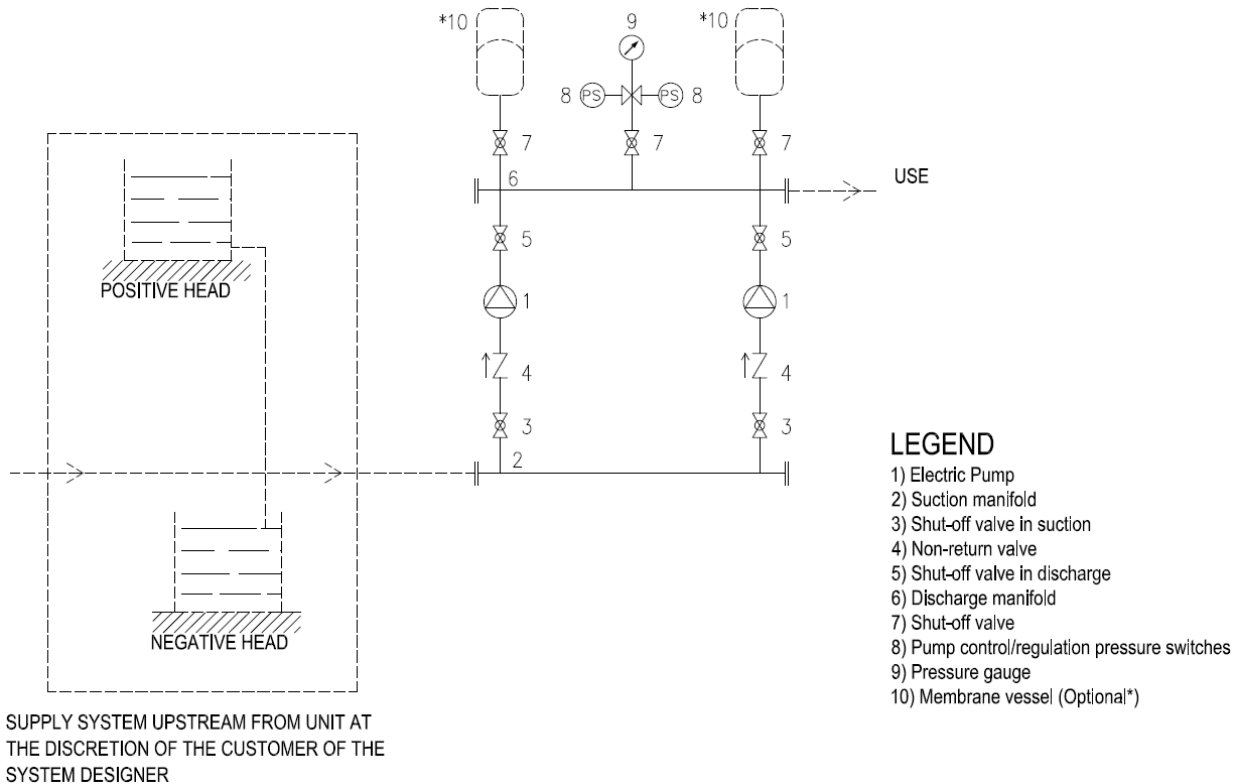

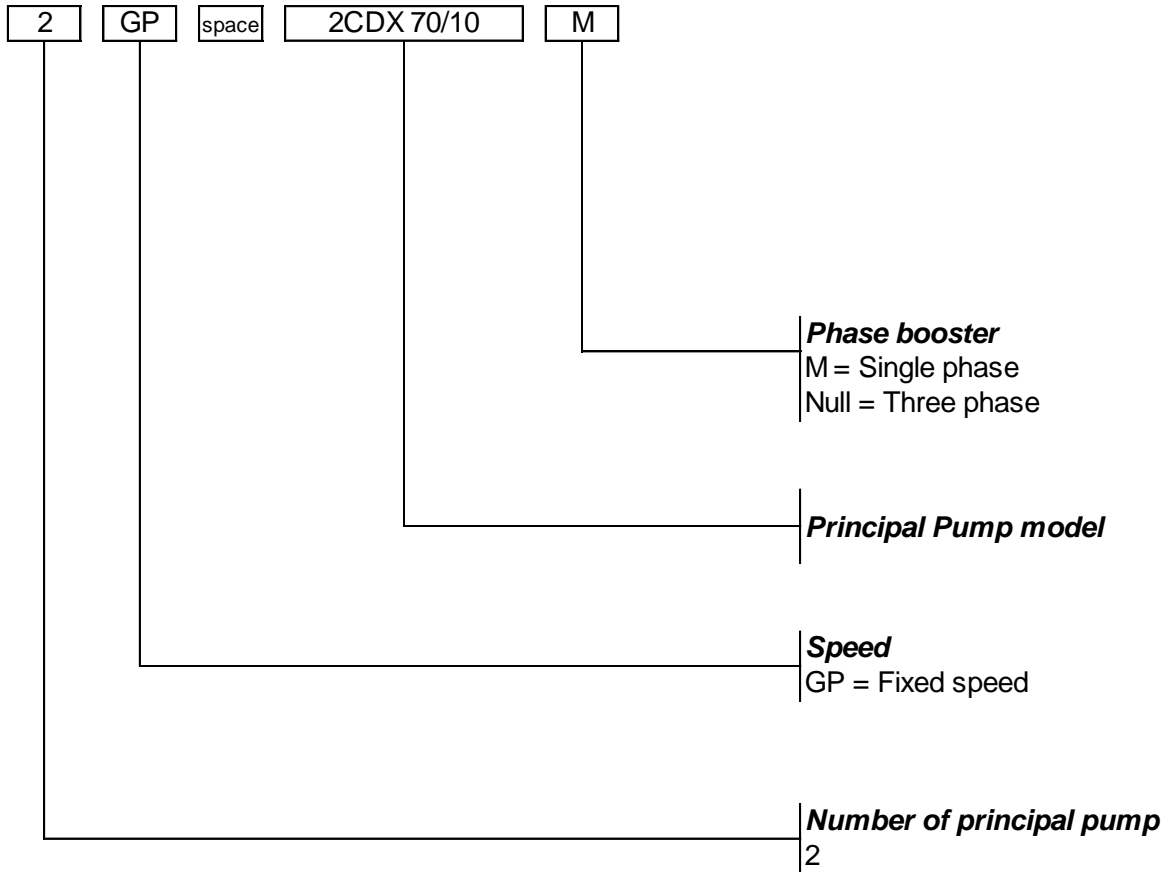

TYPE KEY

2GP 2CDX



NAME PLATE

 EBARA Via Campo Sportivo, 30 38023 CLES (TN) ITALY		 MADE IN ITALY
BOOSTER UNIT		
TYPE	①	
P/N	②	
S/N	③	

- 1) "TYPE" booster model
- 2) "P/N" booster item number
- 3) "S/N" booster serial number

INTENTIONALLY EMPTY PAGE

PRODUCT SPECIFICATIONS HYDRAULIC COMPONENTS AND CONTROL

BOOSTER SET						
2CDX						
Operating range	Version		70	120	200	
	Nominal flow rate (m ³ /h)	Single pump		4.8	9.0	12.6
		2GP		9.6	18.0	25.2
	Maximum working pressure		10 bar			
	Liquid temperature range		0÷50°C			
	Ambient operating temperature (no higher than 1000 m above sea level)		0÷40°C			
Hydraulic components	Frame		Omega sheet Galvanized steel			
	Manifold suction / discharge		Threaded manifold Galvanized steel			
	Closing manifold		Threaded female cap Brass			
	Check valve		Threaded check valve Brass / NBR			
	Ball valve		Threaded ball valve Brass / PTFE			
	Socket for air feeders		Threaded socket Brass			
Control	Pressure gauge		M3A-ABS 50/FR plastic-copper alloy			
	Pressure switches		XMP / -25°C...+70°C			

ELECTRIC PANEL

BOOSTER SET					
2CDX					
Operating range	Version		70	120	200
	Nominal flow rate (m ³ /h)	Single pump	4.8	9.0	12.6
		2GP	9.6	18.0	25.2
Control panel	Principal Electric panel		EP fixed speed		

● : Standard ○ : Optional

TECHNICAL PUMP DATA

PUMP				
2CDX				
Operating range	Version	70	120	200
	Maximum working pressure	0.8 Mpa (8 bar)		
	Liquid temperature range	-5°C to +60°C -5°C to +110°C (H-HS-HW-HSW)		
Liquid handled	Liquid type	Clean water		
Key components material	Casing	EN 1.4301 (AISI 304) (AISI 316) only for "L" version		
	Impeller			
	Casing cover			
	Shaft seal	Ceramic/Carbon/NBR		
	Shaft	AISI 304/AISI 316 (wet extension)		
	Bracket	Aluminium (up to 1.5 kW included) Cast iron (2.2 kW and above)		
Pipe connection	Suction	G 1" ¼		G 1" ½
		UNI ISO 228-1		
	Discharge	G 1" UNI ISO 228-1		

TECHNICAL MOTOR DATA

MOTOR				
2CDX				
Power source	Frequency	50 Hz		
	Phase	Single-phase	Three-phase	
	Rotation speed	2800 min ⁻¹		
	Power rating	0.75 ÷ 1.5 kW	0.75 ÷ 3.7 kW	
		1 ÷ 2 HP	1 ÷ 5 HP	
Voltage	230 ± 10% V	230/400 ± 10%		
Type	Type	Electric - TEFC		
	Efficiency level	-	IE3 from 0.75 kW up to 3.7 kW	
	N° of poles	2		
	Protection degree	IP 55		
	Insulation class	F		
Others	Capacitor	Built in	-	
	Overload protection	Built in	Provided by the user	
	Casing Material	Aluminium		
	Motor support	Aluminium		

INTENTIONALLY EMPTY PAGE

PERFORMANCE RANGE RESEAU BOOSTER SET 2GP 2CDX(.)

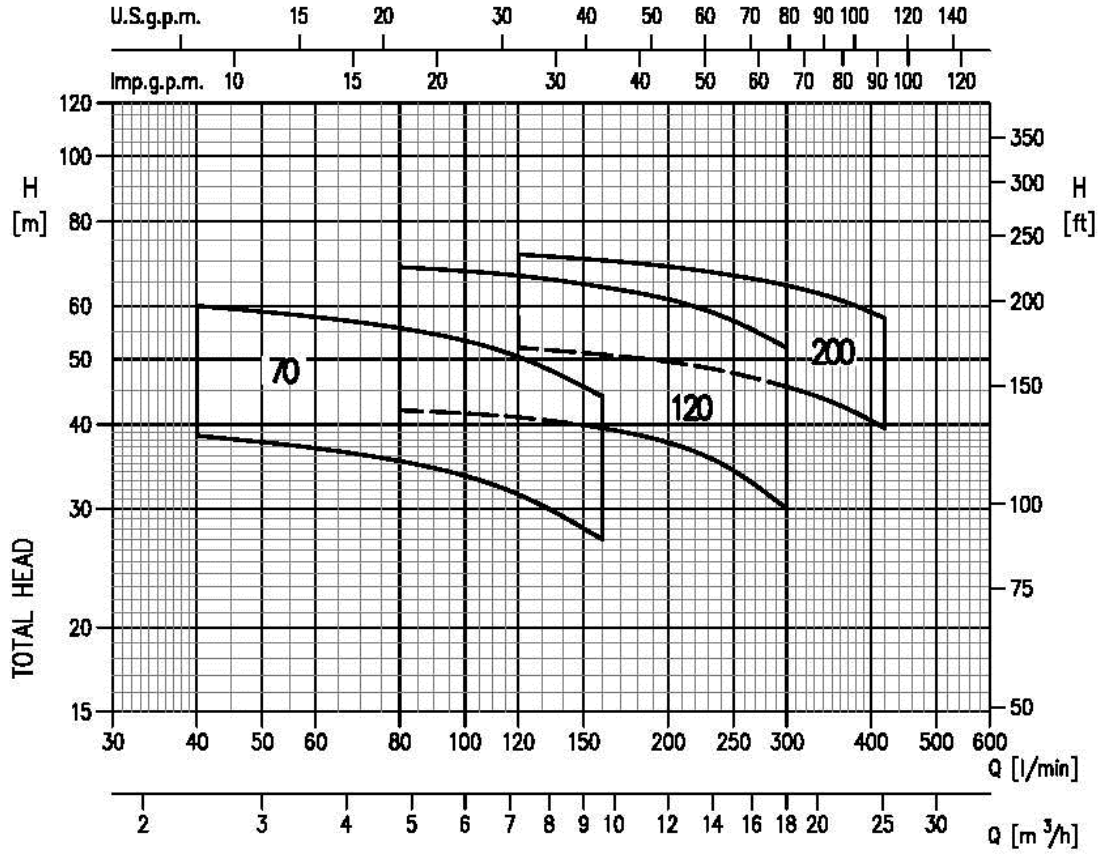

INTENTIONALLY EMPTY PAGE

CURVE SPECIFICATION 2GP

The specifications below qualify the curves shown on the following pages.

Tolerances according to ISO 9906 Annex A

The curves refer to effective speed of asynchronous motors at 50 Hz

Measurements were carried out with clean water at 20°C of temperature and with a kinematic viscosity of $\nu = 1 \text{ mm}^2/\text{s}$ (1 cSt)

The NPSH curve is an average curve obtained in the same conditions of performance curves.

The continuous curves indicate the recommended working range. The dotted curve is only a guide.

In order to avoid the risk of over-heating, the pumps should not be used at a flow rate below 10% of best efficiency point.

Symbols explanation:

Q = volume flow rate

H = total head

P2 = pump power input (shaft power)

η = pump efficiency

NPSH = net positive suction head required by the pump

SELECTION CHART 2GP 2CDX(.)

Model	Supply		Motor		Maximum working pressure (MPa)	Q=Capacity									
	Single phase	Three phase	kW	HP		l/min	0	40	80	120	160	240	300	360	420
						m ³ /h	0	2.4	4.8	7.2	9.6	14.4	18.0	21.6	25.2
H=Total manometric head in meters															
2GP 2CDX 70/10(M)	●	●	0.75+0.75	1+1	0.6	41.0	38.5	35.3	31.5	27.0	-	-	-	-	
2GP 2CDX 70/12(M)	●	●	0.9+0.9	1.2+1.2		48.0	44.5	40.3	35.5	30.0	-	-	-	-	
2GP 2CDX 70/15(M)	●	●	1.1+1.1	1.5+1.5		56.0	52.5	48.0	42.8	36.5	-	-	-	-	
2GP 2CDX 70/20(M)	●	●	1.5+1.5	2+2		64.0	60.0	55.6	50.4	44.0	-	-	-	-	
2GP 2CDX 120/15(M)	●	●	1.1+1.1	1.5+1.5	0.8	46.0	-	42.0	41.0	39.5	35.0	30.0	-	-	
2GP 2CDX 120/20(M)	●	●	1.5+1.5	2+2		55.0	-	51.5	49.5	47.4	41.8	36.5	-	-	
2GP 2CDX 120/30	-	●	2.2+2.2	3+3		63.0	-	59.0	57.0	54.6	49.2	44.0	-	-	
2GP 2CDX 120/40	-	●	3+3	4+4		71.5	-	68.5	66.5	64.0	58.0	52.0	-	-	
2GP 2CDX 200/30	-	●	2.2+2.2	3+3		55.0	-	-	52.0	50.8	48.1	45.5	42.7	39.5	
2GP 2CDX 200/40	-	●	3+3	4+4		66.0	-	-	62.5	61.1	58.0	55.2	52.3	49.0	
2GP 2CDX 200/50	-	●	3.7+3.7	5+5		75.0	-	-	71.5	70.1	67.0	64.3	61.2	57.5	

● : Standard ○ : On request

PERFORMANCE CURVE 2GP 2GP 2CDX 70/10(M)

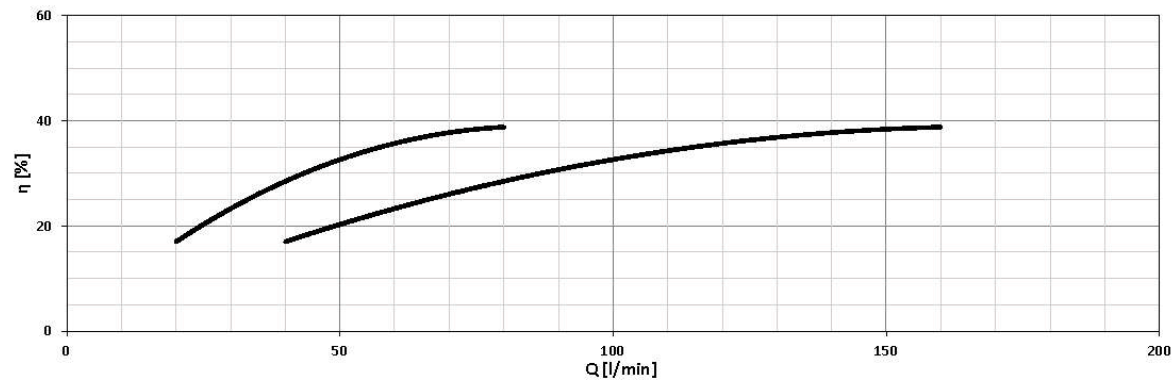
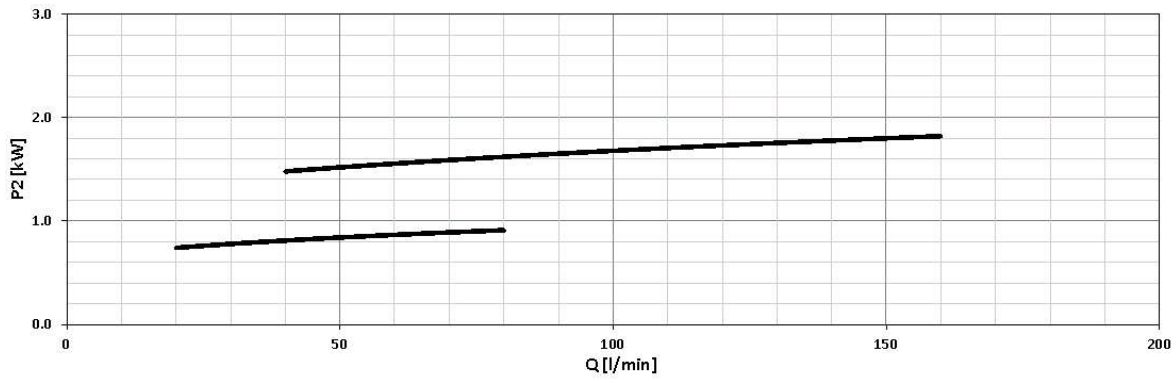
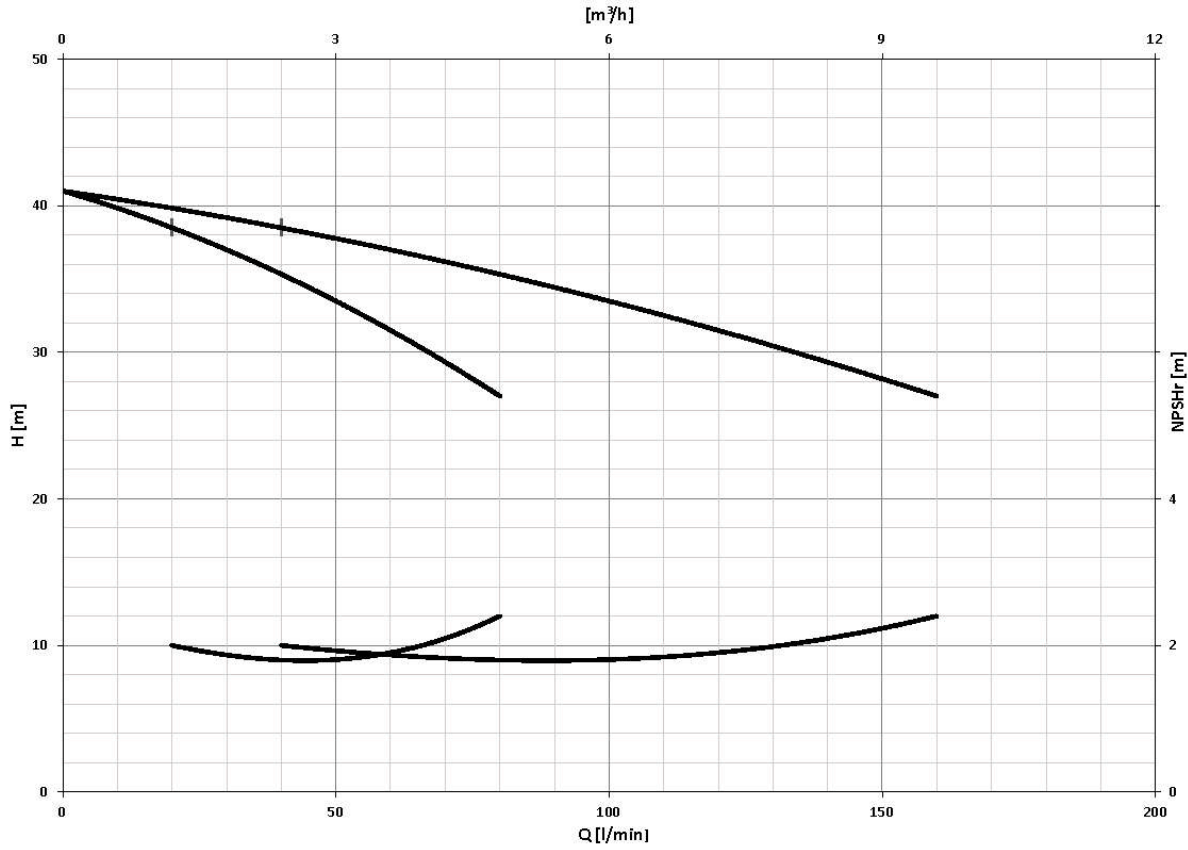

2GP 2CDX 70/12(M)

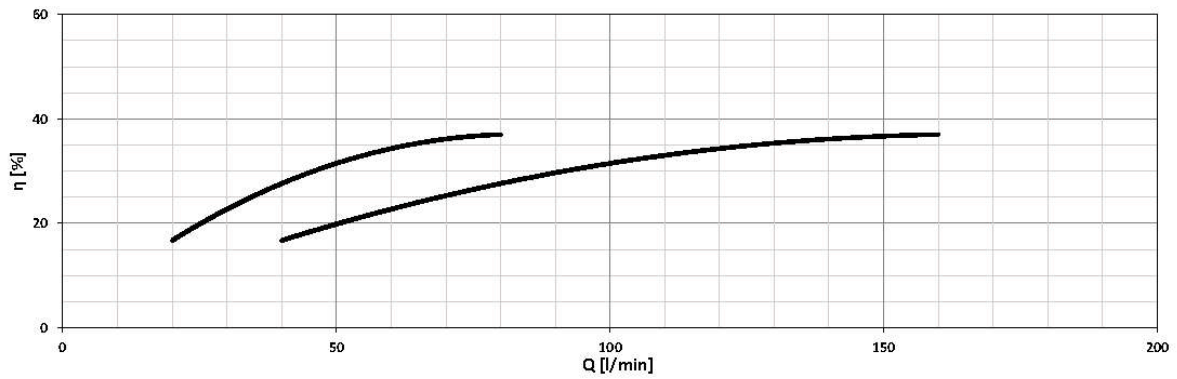
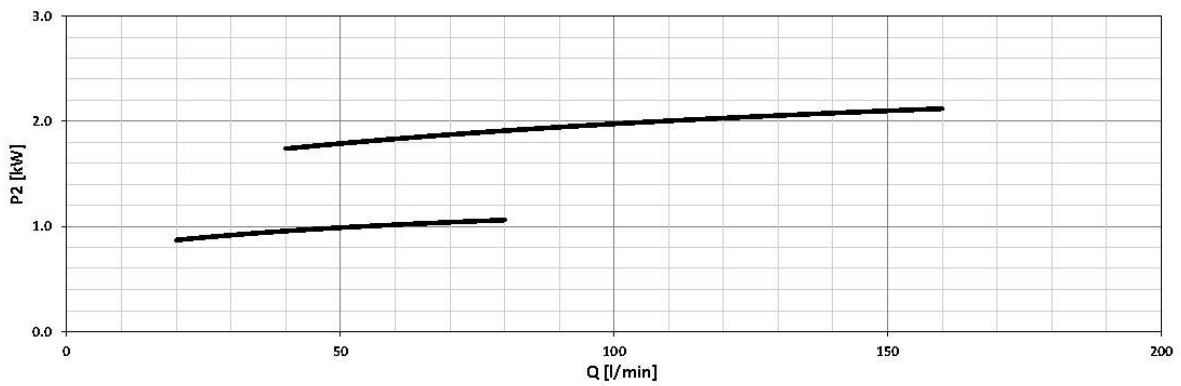
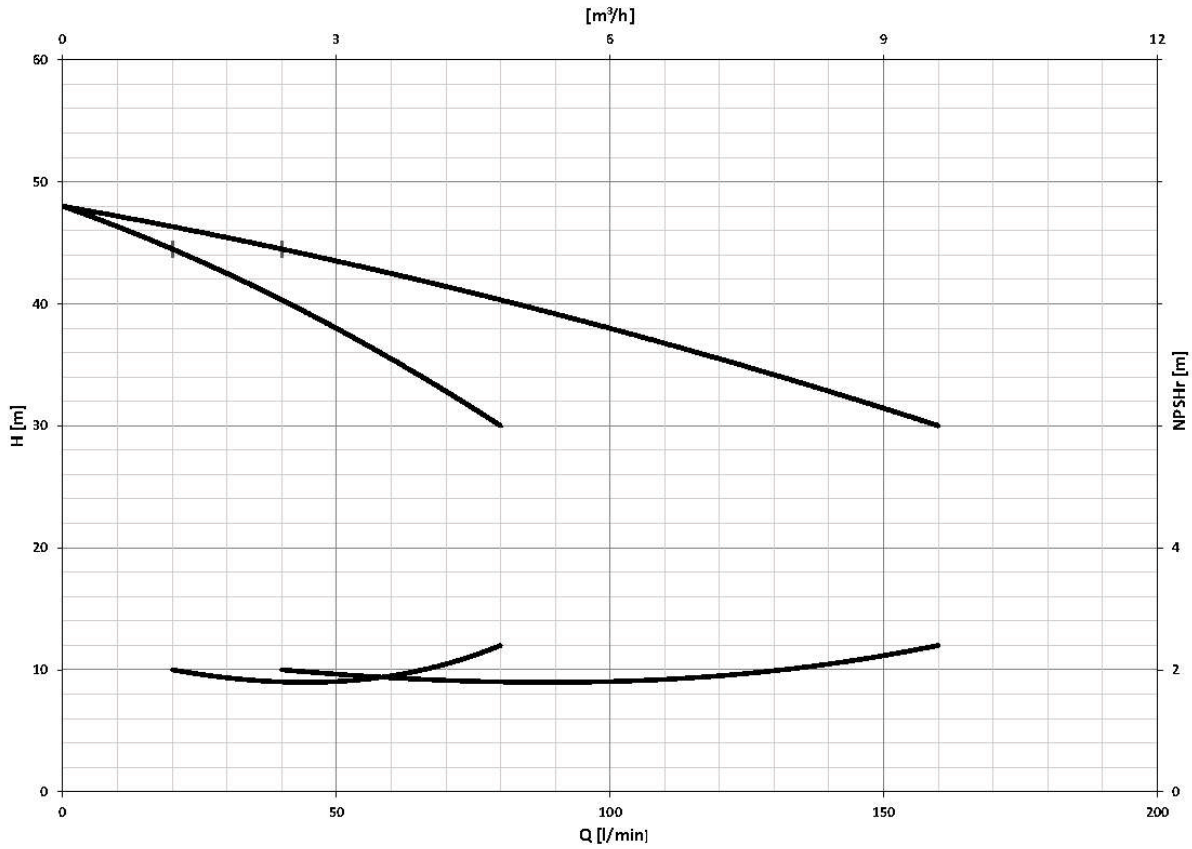

2GP 2CDX 70/15(M)

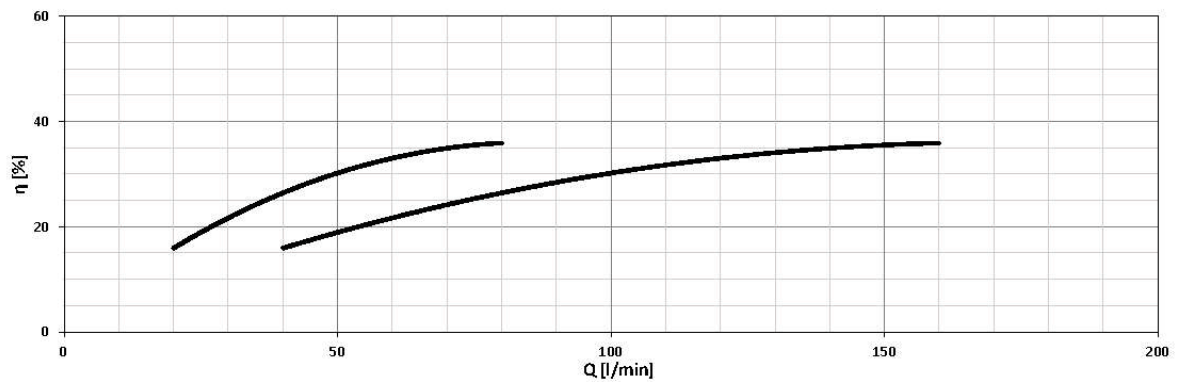
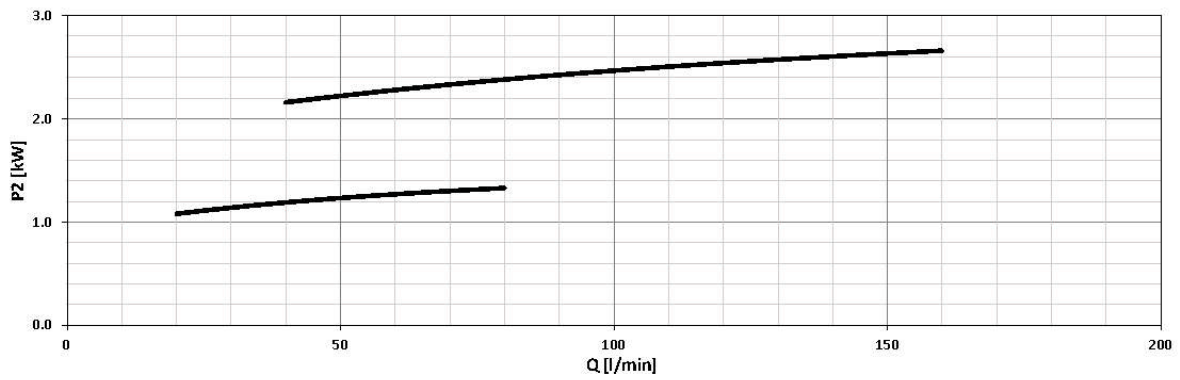
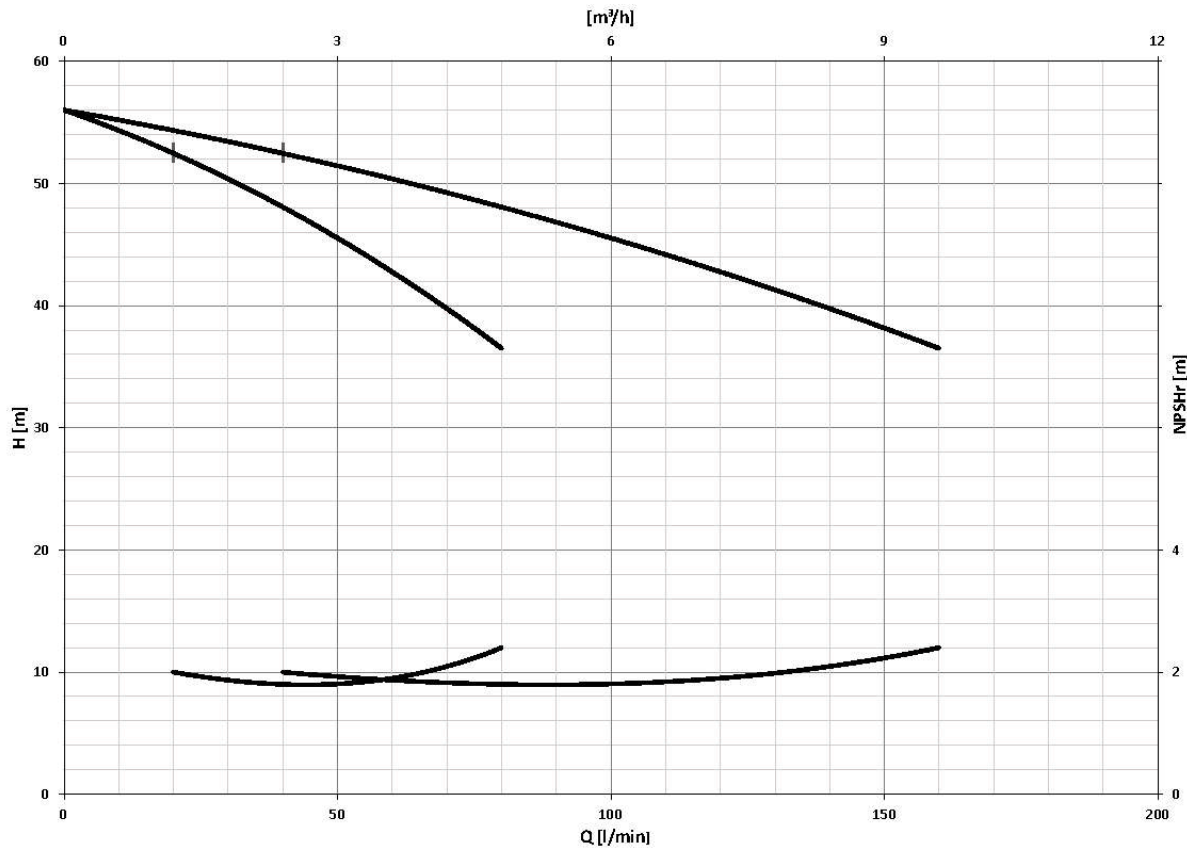

2GP 2CDX 70/20(M)

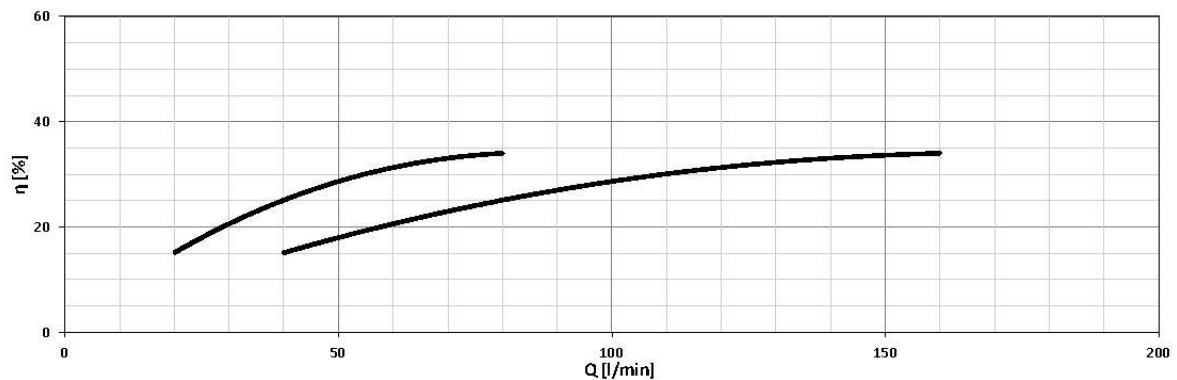
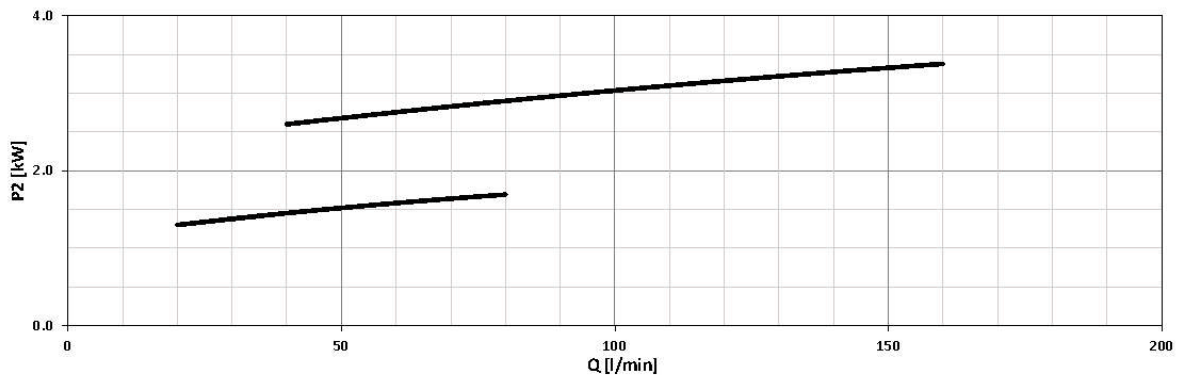
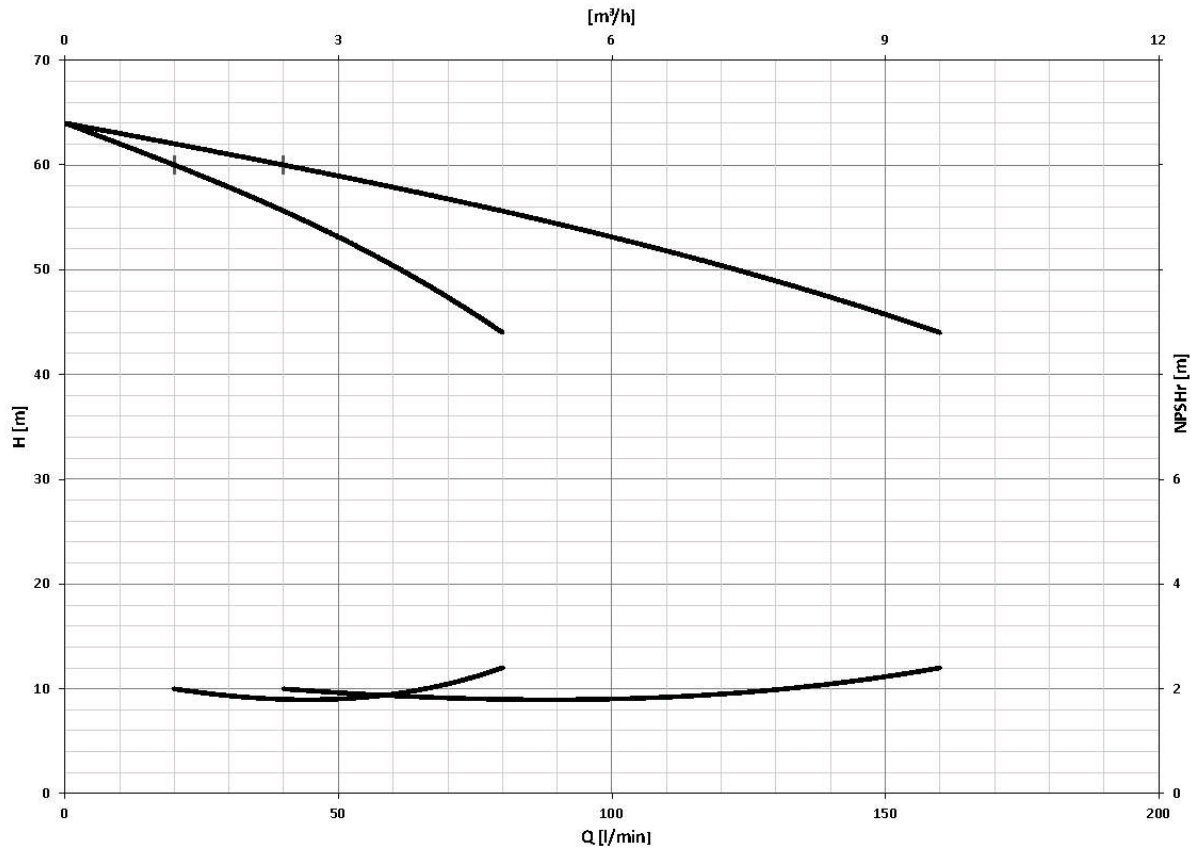

2GP 2CDX 120/15(M)

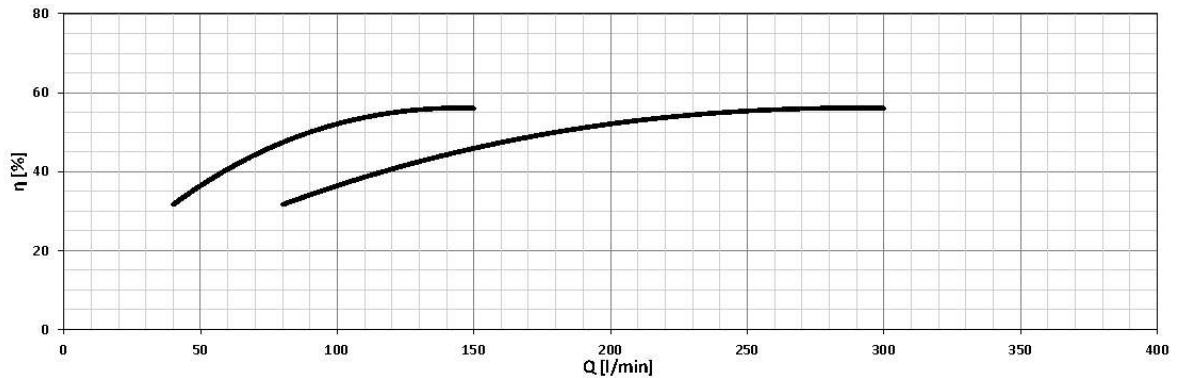
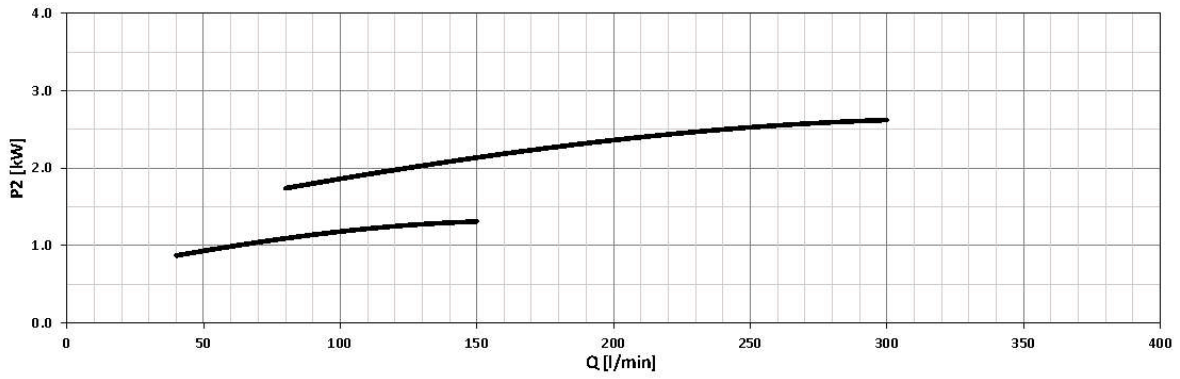
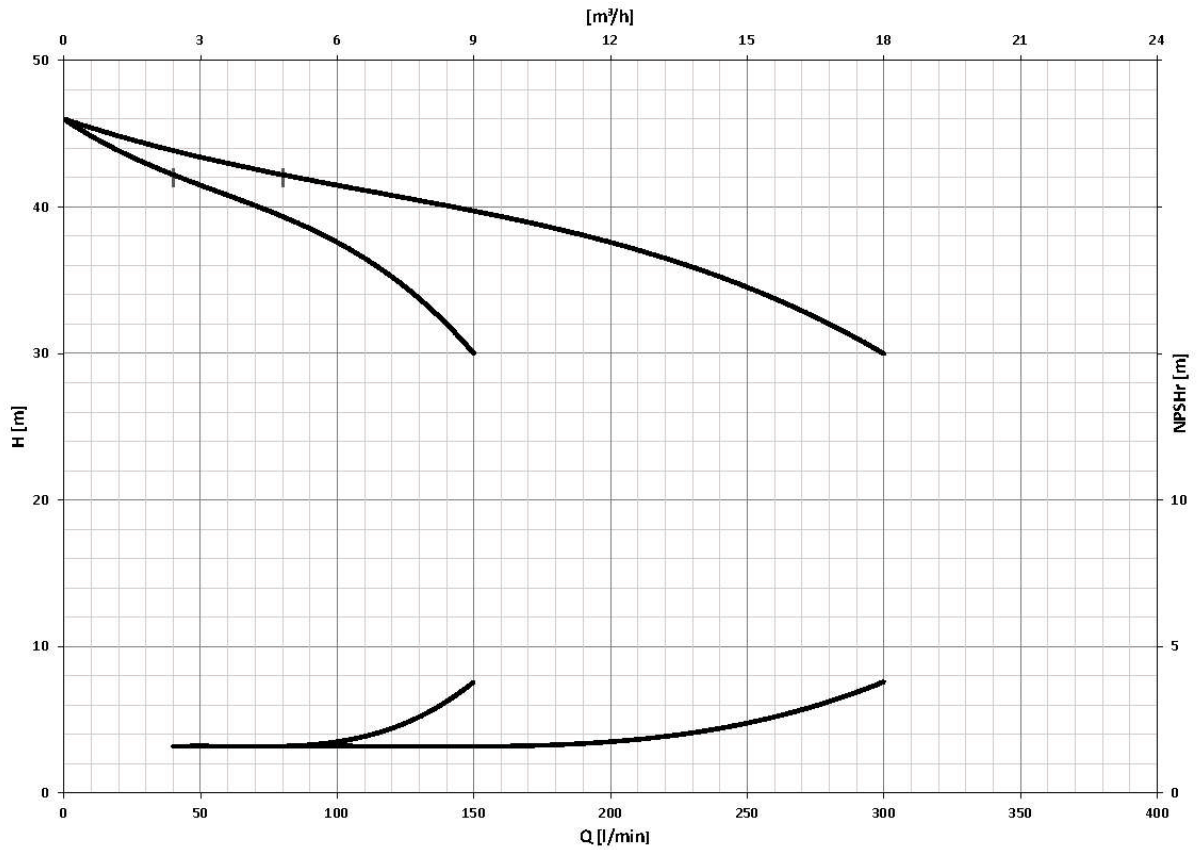

2GP 2CDX 120/20(M)

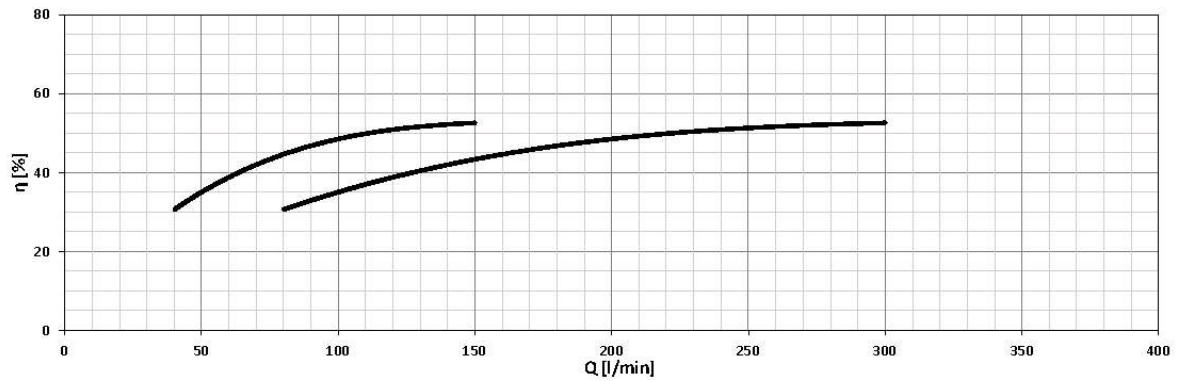
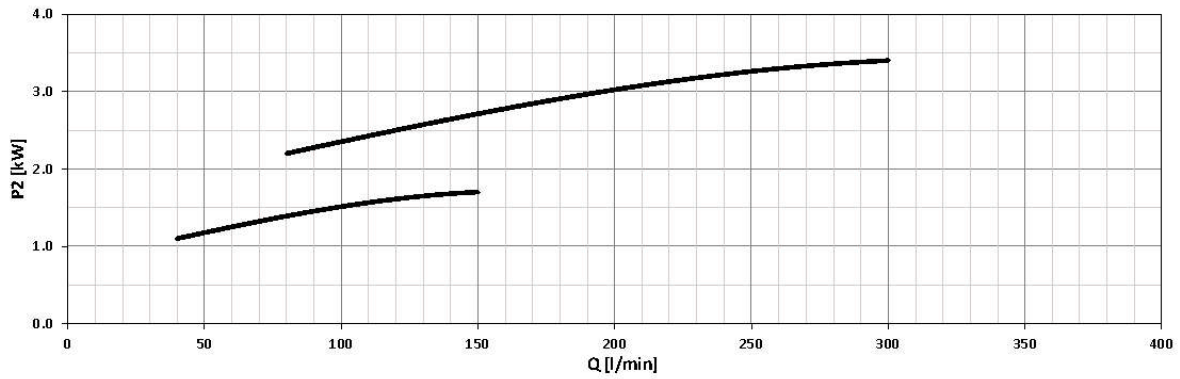
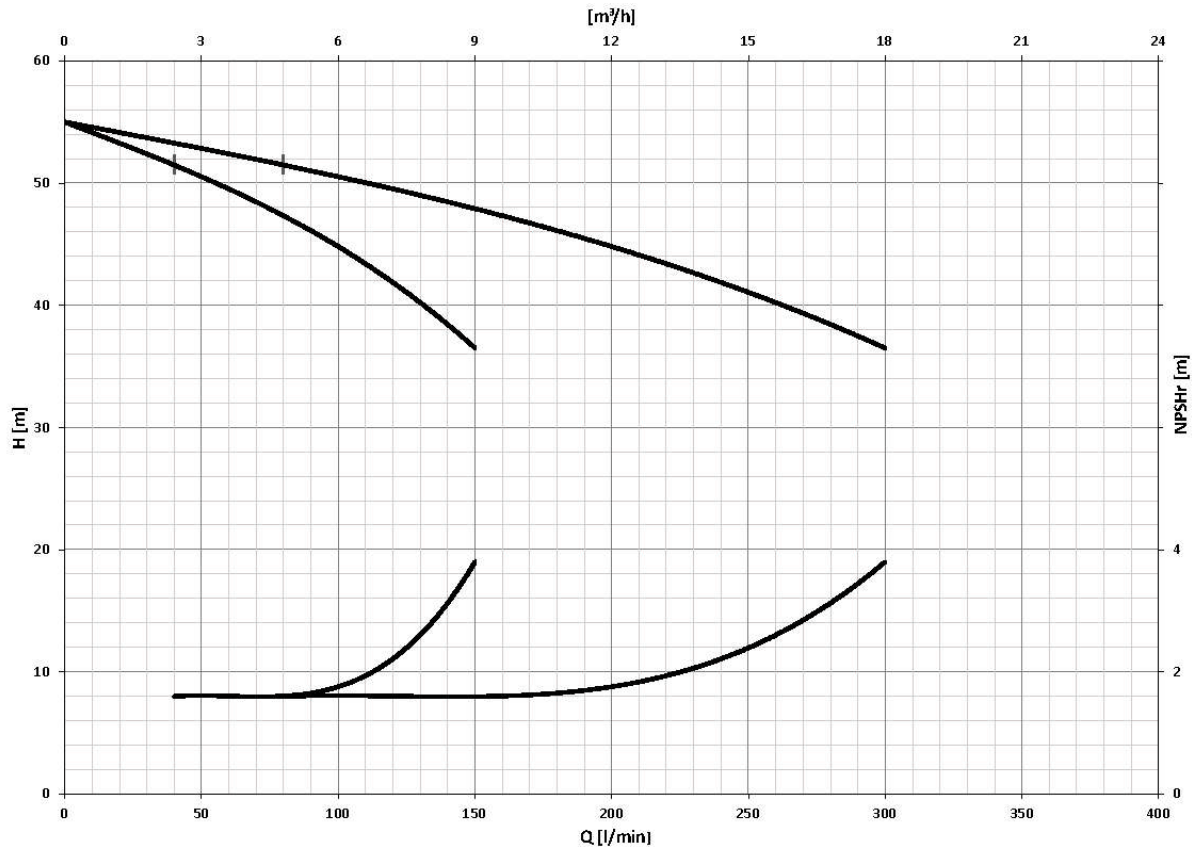

2GP 2CDX 120/30

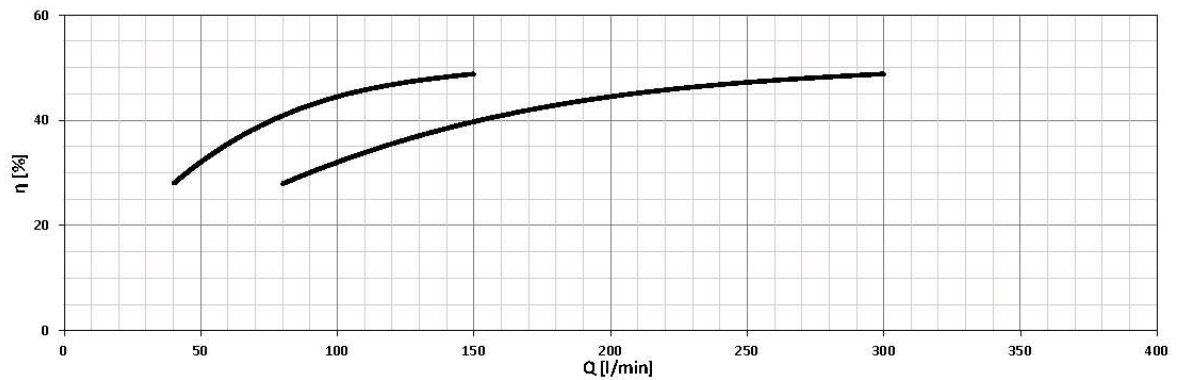
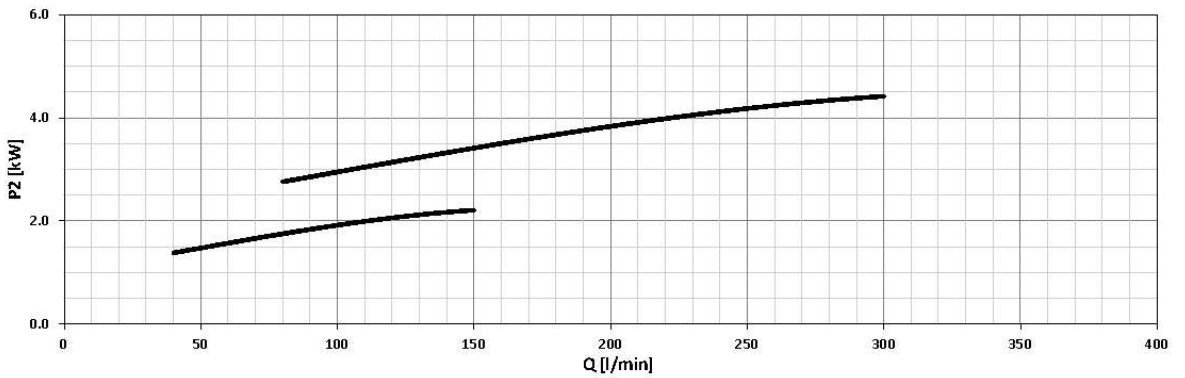
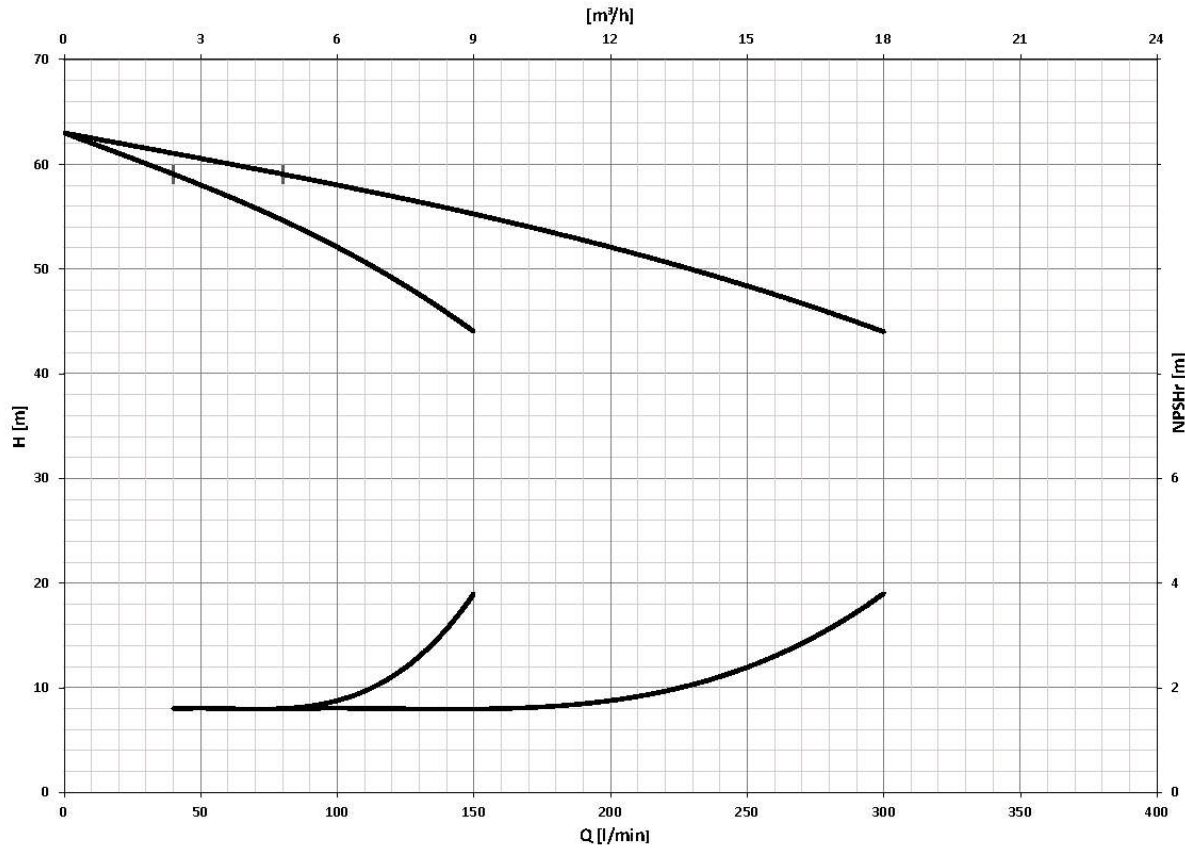

2GP 2CDX 120/40

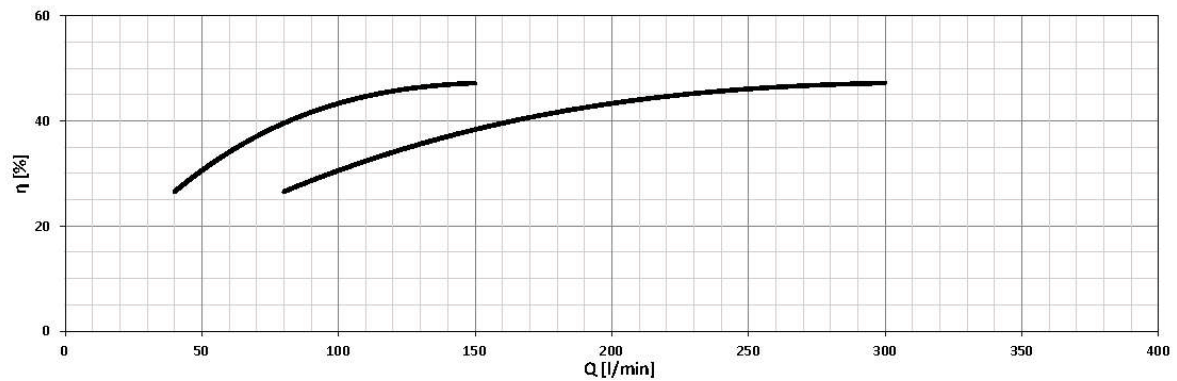
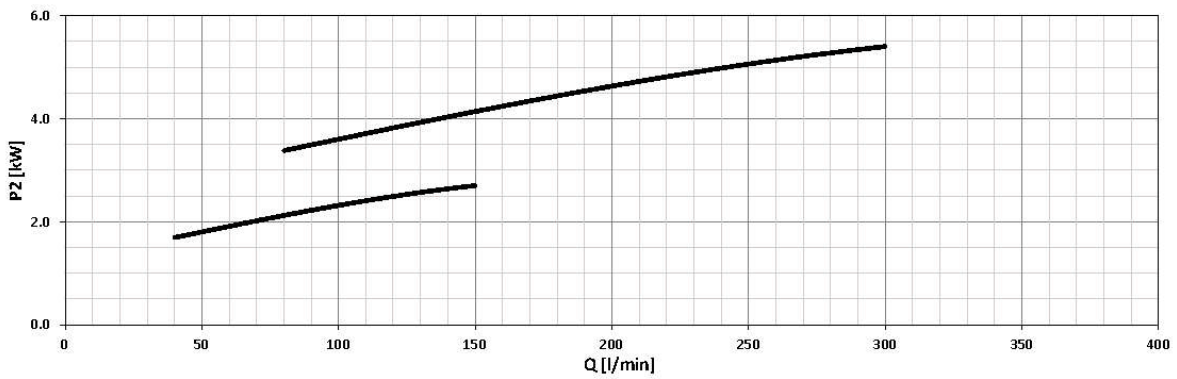
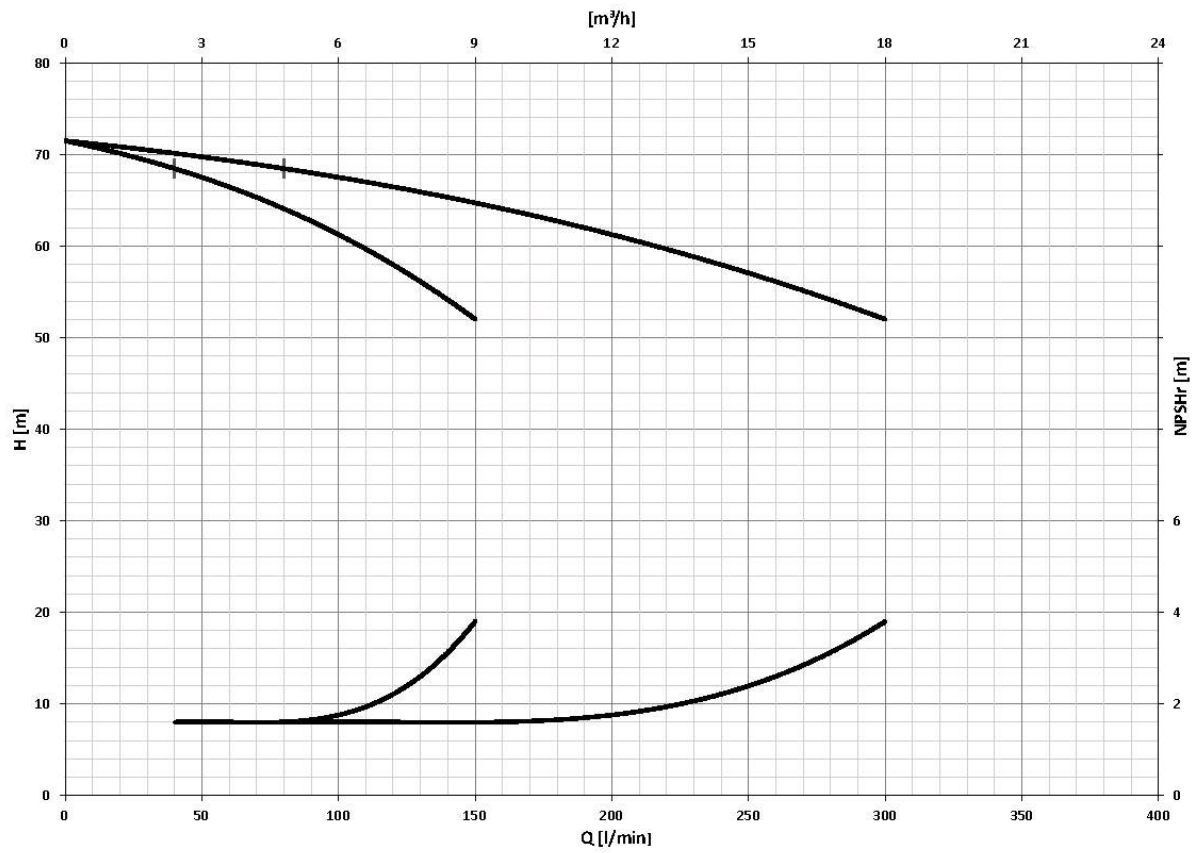

2GP 2CDX 200/30

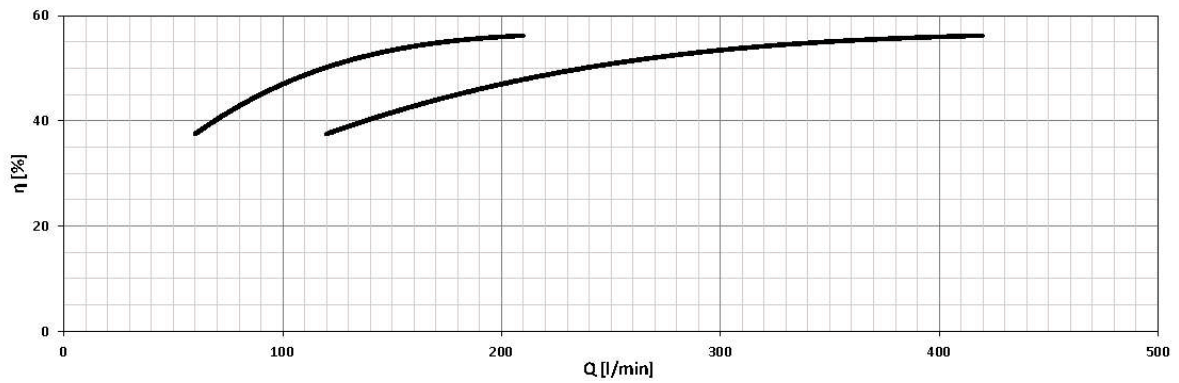
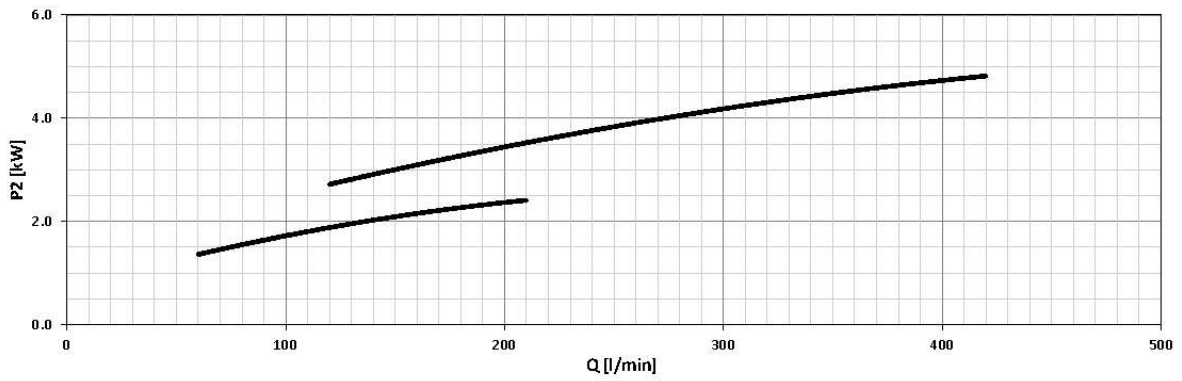
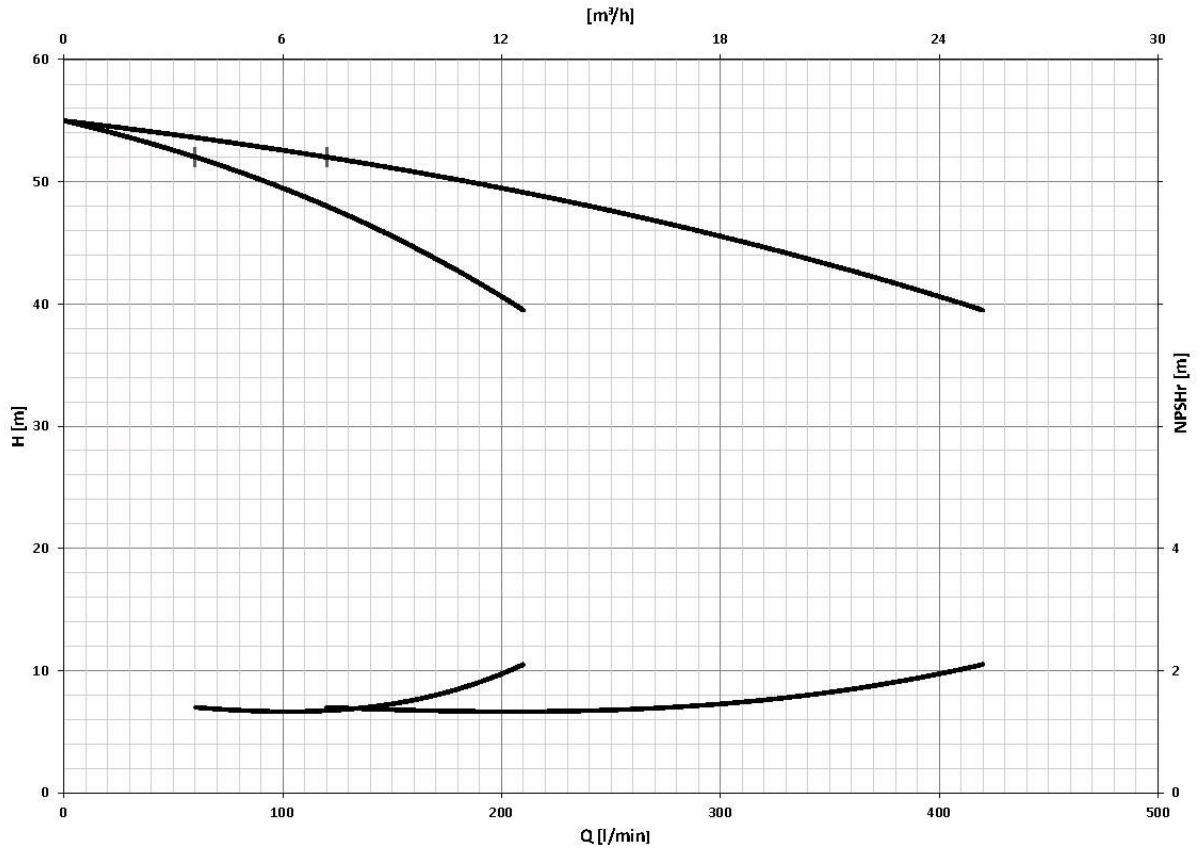

2GP 2CDX 200/40

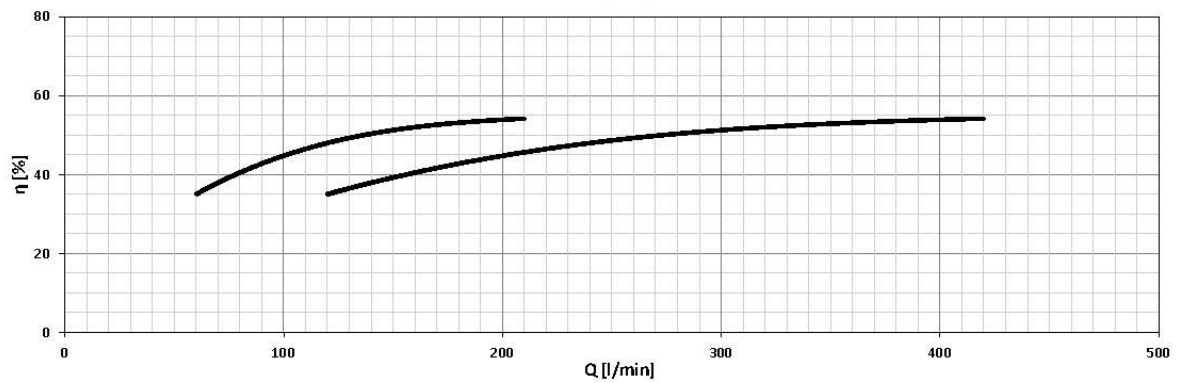
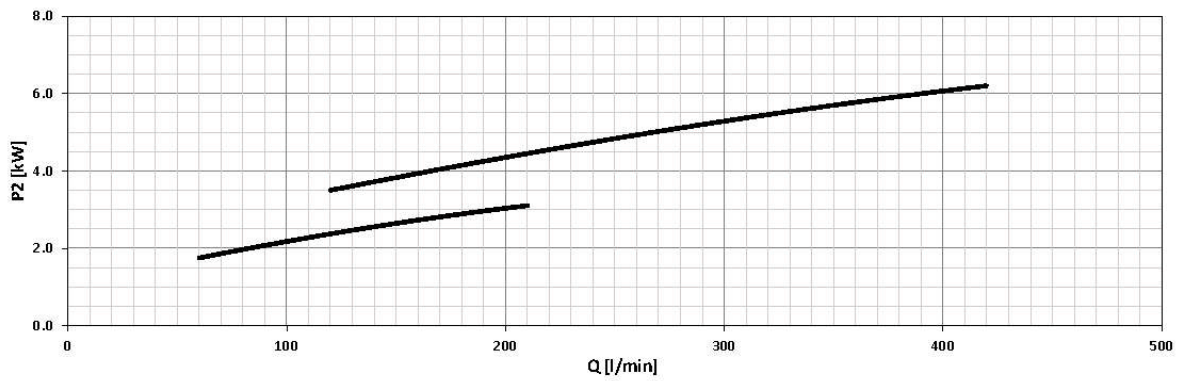
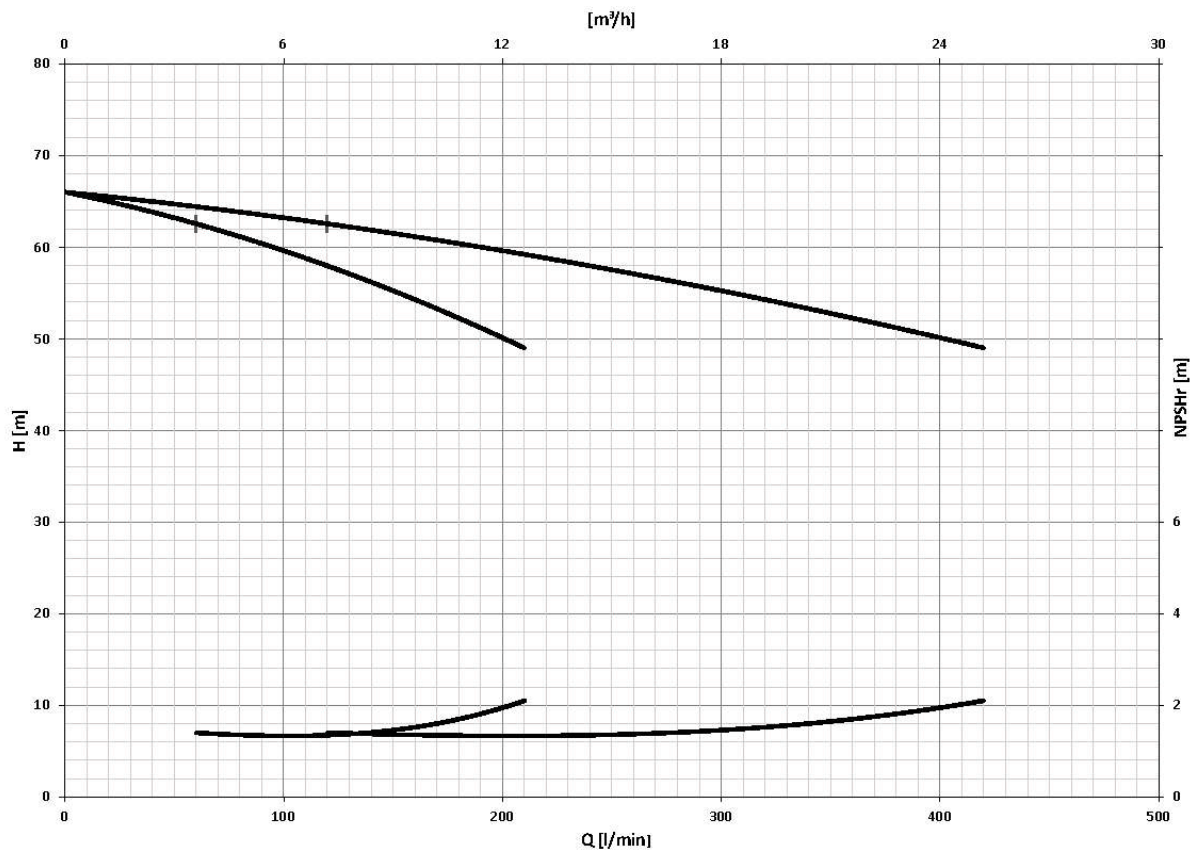

2GP 2CDX 200/50

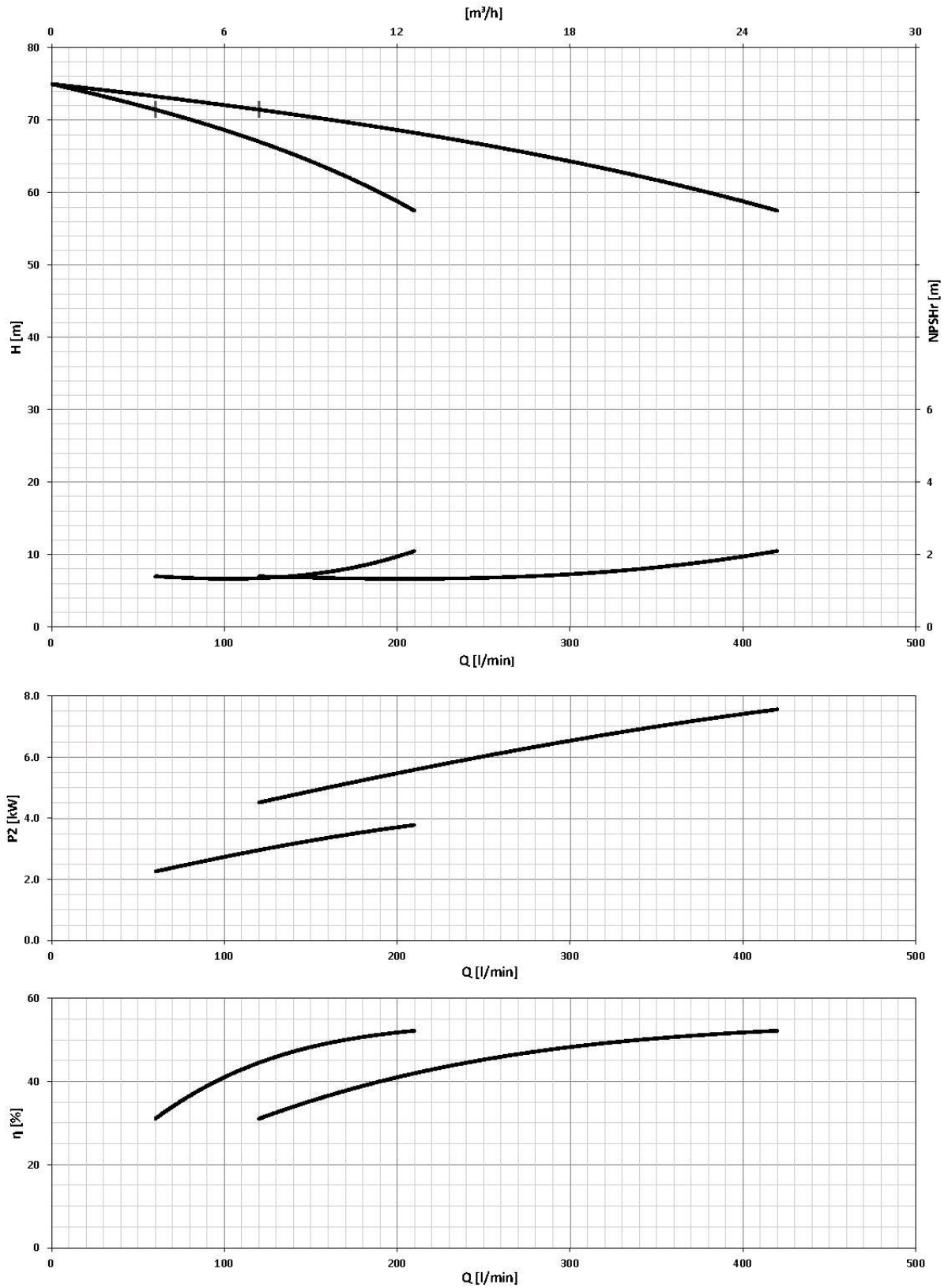

INTENTIONALLY EMPTY PAGE

2GP CONSTRUCTION EXTERNAL VIEW 2GP 2CDX(.) 70-120

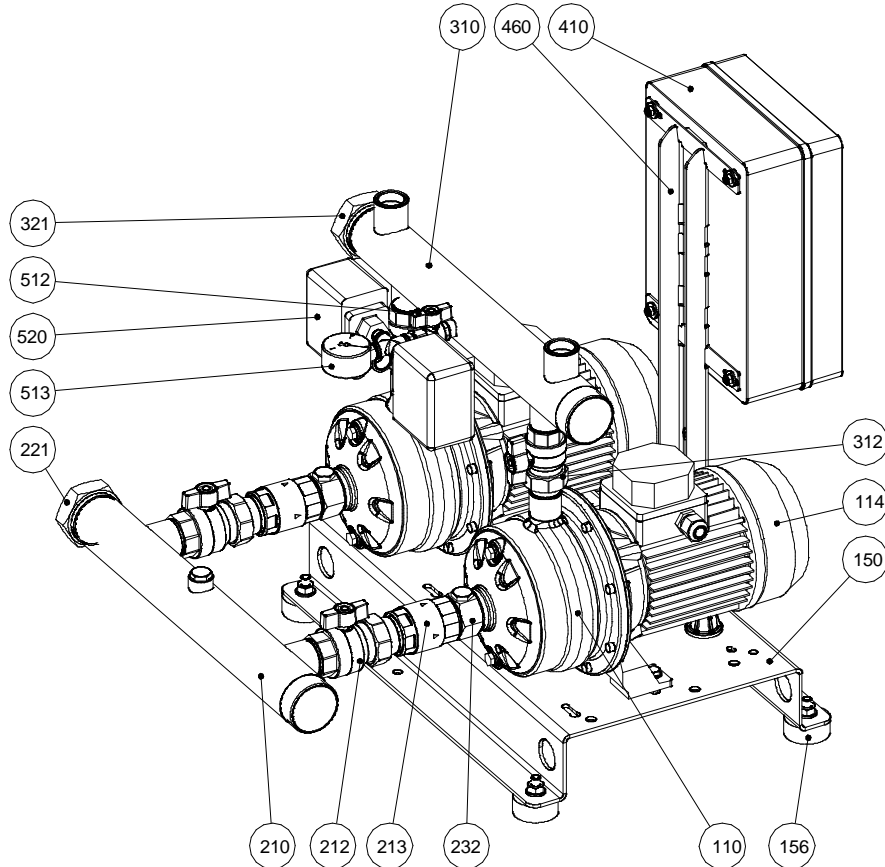

N°	PART NAME	MATERIAL	Quantity
110	Principal pump	-	2
114	Electric motor	-	2
150	Basement	Galvanized steel	1
156	Basement foot	SBR	4
210	Suction manifold	Galvanized steel	1
212	Union ball valve	CW617N / CW614N	2
213	Check valve	Brass / NBR	2
221	Threaded female cap	Galvanized steel	1
232	Nipple for air feeders	Yellow brass	2
310	Discharge manifold	Galvanized steel	1
312	Union ball valve	CW617N / CW614N	2
321	Threaded female cap	Galvanized steel	1
410	Control panel	-	1
460	Control panel frame	Galvanized steel	1
512	Ball valve	CW617N / CW614N	1
513	Pressure gauge	Copper alloy / plastic	1
520	Pressure switches	-	2

EXTERNAL VIEW 2GP 2CDX(.) 200

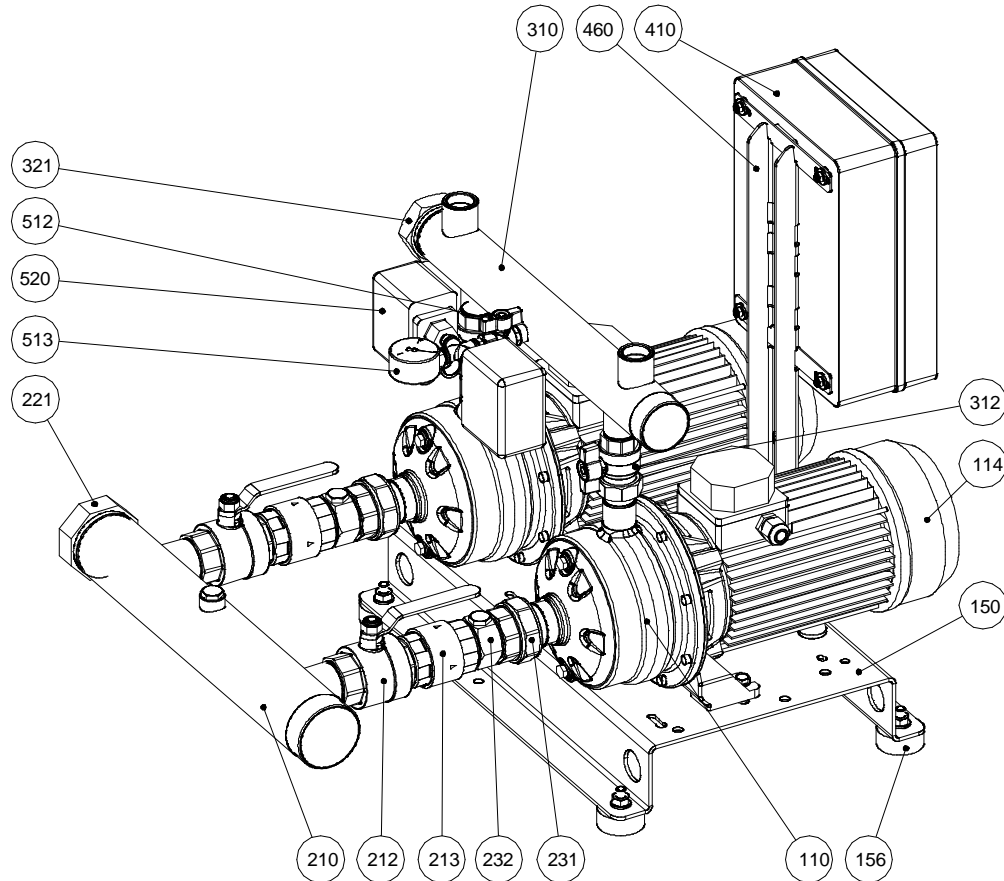

N°	PART NAME	MATERIAL	Quantity
110	Principal pump	-	2
114	Electric motor	-	2
150	Basement	Galvanized steel	1
156	Basement foot	SBR	4
210	Suction manifold	Galvanized steel	1
212	Ball valve	CW617N / CW614N	2
213	Check valve	Brass / NBR	2
221	Threaded female cap	Galvanized steel	1
231	Union 3 pcs	Yellow brass	2
232	Nipple for air feeders	Yellow brass	2
310	Discharge manifold	Galvanized steel	1
312	Union ball valve	CW617N / CW614N	2
321	Threaded female cap	Galvanized steel	1
410	Control panel	-	1
460	Control panel frame	Galvanized steel	1
512	Ball valve	CW617N / CW614N	1
513	Pressure gauge	Copper alloy / plastic	1
520	Pressure switches	-	2

602

EBARA Pumps Europe

EBARA Pumps Europe reserves the right to make changes without prior notice



OVERALL DIMENSIONS 2GP BOOSTER SET 2GP 2CDX(.)

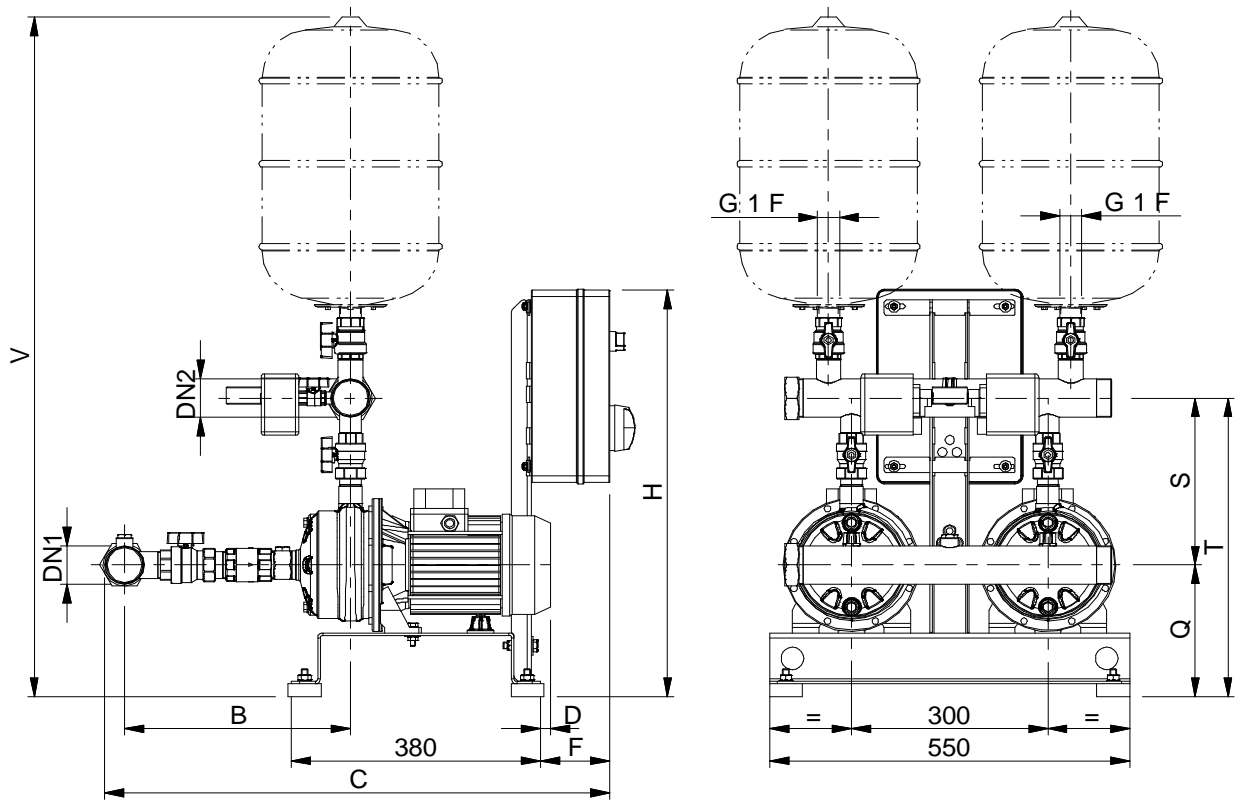

Booster Type	Dimensions [mm]												Weight [kg]				
	DN1	DN2	B	1~ C	3~ C	1~ D	3~ D	1~ F	3~ F	1~ H	3~ H	Q	S	T	V	1~	3~
2GP 2CDX 70/10(M)	50	40	345	735	765	-	-	75	105	630	635	205	255	460	1050	58	59
2GP 2CDX 70/12(M)	50	40	345	735	765	-	-	75	105	630	635	205	255	460	1050	59	62
2GP 2CDX 70/15(M)	50	40	345	740	770	5	30	75	105	630	635	220	265	480	1070	67	68
2GP 2CDX 70/20(M)	50	40	345	740	770	15	35	75	105	630	635	220	265	480	1070	69	74
2GP 2CDX 120/15(M)	50	50	345	740	770	5	30	75	105	630	635	205	260	465	1060	65	66
2GP 2CDX 120/20(M)	50	50	345	740	770	15	35	75	105	630	635	205	260	465	1060	67	71
2GP 2CDX 120/30	50	50	345	-	785	-	15	-	105	-	635	220	270	490	1085	-	87
2GP 2CDX 120/40	50	50	345	-	785	-	65	-	105	-	635	220	270	190	1085	-	90
2GP 2CDX 200/30	65	50	410	-	855	-	65	-	105	-	635	205	260	465	1060	-	90
2GP 2CDX 200/40	65	50	410	-	855	-	65	-	105	-	635	220	270	490	1085	-	92
2GP 2CDX 200/50	65	50	410	-	870	-	75	-	105	-	635	220	270	490	1085	-	108

PACKING

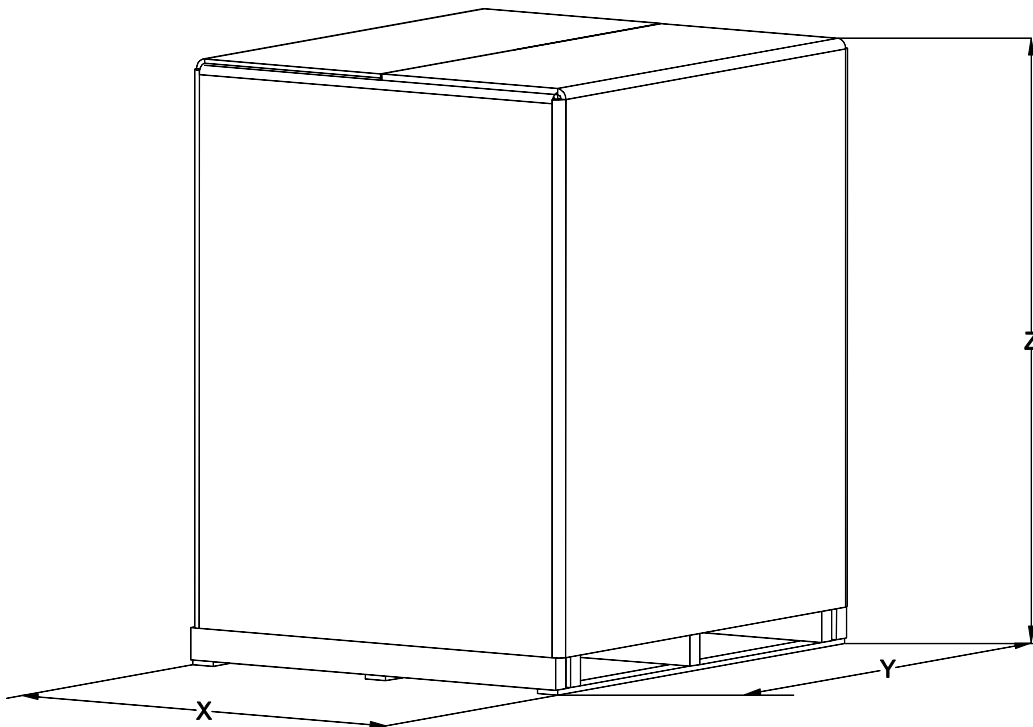

	Booster type	Overall dimensions packing			Booster+packing Weight [kg]
		X	Y	Z	
2GP	2GP 2CDX 70/10(M)	690	890	780	84
	2GP 2CDX 70/12(M)				87
	2GP 2CDX 70/15(M)				93
	2GP 2CDX 70/20(M)				99
	2GP 2CDX 120/15(M)				91
	2GP 2CDX 120/20(M)				96
	2GP 2CDX 120/30				112
	2GP 2CDX 120/40	115			
	2GP 2CDX 200/30	1230	830	1365	115
	2GP 2CDX 200/40				117
	2GP 2CDX 200/50				133

CONTROL PANEL FIXED SPEED 2EP SPECIFICATION

- **SERIES 2EP M UA (single-phase power output)**
- **SERIES 2EP T UA (three-phase power output)**

Electrical panel (protection and control) for two electropumps. Manual or automatic operation through pressure switches or floats. The panel is configured to start the two pumps alternately in stand-by to pressure switch / float switch enable signals. The electrical panel protects the motors against overload and phase failure. Any protection devices that intervene are signalled on the panel itself and remotely through no voltage contacts. The protection device against overload and phase failure resets automatically three times, and manually after the fourth intervention (any interventions, from 1 to 3, are cancelled one hour after the last intervention).

TECHNICAL FEATURES

- P.MIN= Operation against dry running (tripped by a level float or minimum pressure switch) with automaticreset once water supply is restored, with warning lamp.
- PR1= Pump n. 1 start/stop
- PR2= Pump n. 2 start/stop
- Automatic start sequence alternation
- Motor protection against overload with automatic reset for three times and manual reset the fourth time
- Motor line protection against short-circuits with fuses for motor startup
- Transformer and auxiliary circuit protection with fuses
- Remote signalling, through NC-NO no voltage contact, of the protection devices that intervene

Version		2EP M UA	2EP T UA
Power source	Frequency	50/60 Hz	
	Phase	Single-phase	Three-phase
	Voltage	230 V ± 10%	400 V ± 10%
	Power	0.75 ÷ 1.5 kW	0.75 ÷ 4 kW
Others	Protection degree	IP 55	
	Ambient Temperature	-5°C + 40°C	
	Pressurisation units	2 pumps	
	Relative humidity	50% a 40°C MAX (90% a 20°C)	
	Max altitude	1000 m (a.s.l.)	
Directives	2014/35/EU (LVD), 2014/30/EU (EMC), 2011/65/EU (RoHS)		

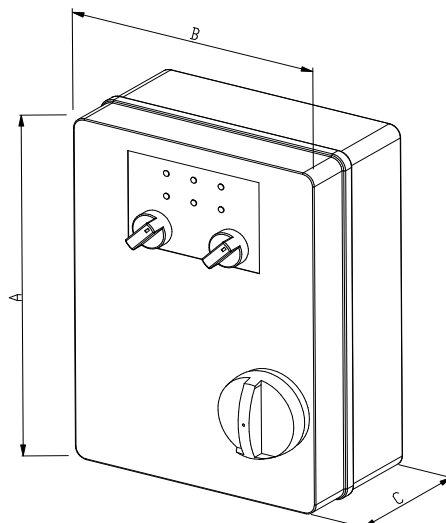

801

2EP M UA MODELS TABLE

Model	Single pump Power [kW]	I Calibration [A]	Range Protection* [A]	Motor fuse	Dimensions AxBxC [mm]	Weight [kg]
2EP 0,75 M	0,75	2x7	1÷12	8A aM (10.3x38)	240 x 190 x 90	1,5
2EP 1,1 M	1,1	2x9	1÷12	10A aM (10.3x38)	240 x 190 x 90	1,5
2EP 1,5 M	1,5	2x12	1÷12	12A aM (10.3x38)	240 x 190 x 90	1,5

* Unipolar amperometric protection.

2 EP T UA MODELS TABLE

Model	Single pump Power [kW]	I Calibration [A]	Range Protection* [A]	Motor fuse	Dimensions AxBxC [mm]	Weight [kg]
2EP 0,75 T	0,75	2x2	1÷12	6A am (10.3x38)	300 x 220 x 120	3,5
2EP 1,1 T	1,1	2x3	1÷12	6A am (10.3x38)	300 x 220 x 120	3,5
2EP 1,5 T	1,5	2x4	1÷12	8A am (10.3x38)	300 x 220 x 120	3,5
2EP 2,2 T	2,2	2x6	1÷12	12A am (10.3x38)	300 x 220 x 120	3,5
2EP 3 T	3	2x8	1÷12	16A am (10.3x38)	300 x 220 x 120	3,5
2EP 4 T	4	2x9	1÷12	20A am (10.3x38)	300 x 220 x 120	3,5

* Electronic amperometric protection (measured current on one phase).

Notes: Standard Control panels EP three-phase are available for 1, 2, 3 pumps until 30kW power
For 4 or more pumps or power above 30kW are available on request

802

EBARA Pumps Europe

EBARA Pumps Europe reserves the right to make changes without prior notice





EBARA Pumps Europe S.p.A.

Via Pacinotti, 32
36040 Brendola (Vicenza), Italia
Phone +39 0444 706811
Fax +39 0444 405811
ebara_pumps@ebaraeurope.com
www.ebaraeurope.com

EBARA Corporation
11-1, Haneda Asahi-cho, Ohta-ku,
Tokyo 144-8510
Japan
Phone +81 3 6275 7598
Fax +81 3 5736 3193
www.ebara.com

